

S SERIES™



S25
20/25/30/35



Max Load Capacity
4000 / 5000 / 6000 / 7000 lbs.
(2000 / 2500 / 3000 / 3500 kg)

CLARK®

S SERIES™

SMART · STRONG · SAFE

Building on over 100 years of lift truck innovations, design and industry firsts. The evolution continues... the CLARK S-Series, the next generation of lift trucks.

■ SMART

Our design standards have historically led the industry in innovation and firsts; the S-Series represents the next phase of lift truck design.

- Interactive Dash
- Built-In Reporting of Truck and Operator Performance via Optional Telemetry
- Engine/Powertrain Protection
- Integrated Systematic Service Tools
- On-Board Reporting of Operator Controlled Functions

■ STRONG

CLARK trucks are "Built to Last"; from our industrial designs to our legacy Dealers our combined strengths ensure a strong performance to your bottom line and overall lower cost of ownership.

- Force-Cooled Wet Disc Brakes
- Fully Welded Heavy Gauge Frame
- Nested I-Beam Upright
- 6-Roller Carriage
- External Side-Thrust Rollers
- Proven Steer Axles and Cooling Systems

■ SAFE

CLARK makes your safety our priority. Safety is and has been a cornerstone of CLARK design standards for over 100 years. Our standards became the industry standards. The S-Series innovates again with standard features including:

- Automatically Applied Parking Brake
- Speed Limit Control
- Increased Visibility
- Optional Rear View Camera
- High-Visibility Orange Seat Belt
- Designed with Optimal Center-of-Gravity to Enhance Truck Stability



*Shown with optional cabin



SMART · STRONG · SAFE

Operator Comfort and Productivity



- Minimal Vibration and Noise to the Operator via a Balanced Engine and Isolated Transmission
- Adjustable Full-Suspension Seat
- Hood-Mounted Levers with Low Input Force
- Large Floor Board Improves Leg Room and Boot Clearance
- Small Diameter Steering Wheel with Low Steering Effort
- Reduced Brake and Inching Pedal Effort
- Steering Column Adjustable Tilt Range of 30°
- Optimized Step Height

Smart Dash



- 5" Color LCD Display
- On-Board Diagnostics
- CANbus Communication
- Password Protected Engine Start Through Dash
- Powertrain Protection Monitoring System

S SERIES™



Low Cost of Ownership



- 500 Hour Oil Service Interval on FORD and Isuzu Engines
- 2,000 Hour Oil Service Interval on Transmission (for General Warehouse Applications)
- Optimized Hydraulic Operating Pressure Reduces Fuel Consumption
- Separate Transmission and Axle Simplify Servicing
- Open Core Radiator is Standard
- Engine Efficiency/Performance Reduces Fuel Consumption
- DOC (Diesel Oxidation Catalyst)
- Force Cooled Wet Disc Brakes

High Performance Engines

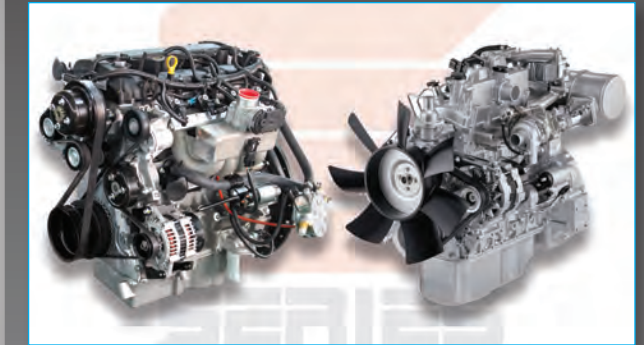

FORD 2.5L LPG Tier-4

- Balanced Engine
- 4-Cylinder Dual Overhead Cam Design
- VVT (Variable Valve Timing)
- Sequential Multi-Port Fuel Injection
- Timing Chain-Driven Camshaft
- Automatic Belt Tensioners

ISUZU 4LE2X 2.2L Diesel Tier-4 Final

- Turbo-Charged
- High-Pressure Multi-Stage Injection
- DOC (Diesel Oxidation Catalyst)
- No Regeneration (Burn-off) Cycles Necessary
- No UREA Additives

ANSI/ITSDF and Insurance Classification

Standard truck meets all applicable mandatory requirements of Part III-ANSI/ITSDF B56.1 Safety Standard for Powered Industrial Trucks and Underwriters Laboratories requirements as to fire hazard only for D and LP classifications. For further information contact a CLARK representative. Users should be aware of, and adhere to, applicable codes and regulations regarding operator training, use, operation and maintenance of powered industrial trucks, including:

- ANSI/ITSDF B56.1
- NFPA 505, fire safety standard for powered industrial trucks - type designations, areas of use, maintenance and operation.

- Occupational Safety and Health Administration (OSHA) regulations that may apply.

Contact your authorized CLARK forklift truck dealer for further information including operator training programs and auxiliary visual and audible warning systems, fire extinguishers, etc., as available for specific user applications and requirements.

Specifications, equipment, technical data, photos and illustrations are based on information at time of printing and are subject to change without notice. Some products may be shown with optional equipment.

& Don't Forget...Safety Starts With You!

Before operating a lift truck, an operator must:

- Be trained and authorized
- Read and understand operator's manual
- Not operate a faulty lift truck
- Not repair a lift truck unless trained and authorized
- Have the overhead guard and load backrest extension in place
- Perform daily inspections

During operation, a lift truck operator must:

- Wear a seat belt
- Keep entire body inside truck cab
- Never carry passengers or lift people
- Keep truck away from people and obstructions
- Travel with lift mechanism as low as possible and tilted back
- Allow safe stopping distance and come to a complete stop before leaving operator compartment

To park a lift truck, an operator must:

- Completely lower forks or attachments
- Shift into neutral
- Turn key off

SMART • STRONG • SAFE

Upright Table

	Maximum Fork Height		Overall Height ¹ Lowered		Free Lift ³		Standard Tilt Spec ² B°/F°
	in	mm	in	mm	in	mm	
S20/25 Standard 							
83	2120	62.0	1575	4.3	110	6/10	
117	2980	78.9	2005	4.3	110	8/10	
• 130	3300	85.2	2165	4.3	110	10/8	
138	3500	90.7	2305	4.3	110	10/8	
147	3725	96.7	2455	4.3	110	10/8	
152	3860	99.6	2530	4.3	110	10/8	
164	4165	110.2	2800	4.3	110	5/6	
172	4380	118.1	3000	4.3	110	5/6	
182	4620	127.2	3230	4.3	110	5/6	
204	5170	137.6	3495	4.3	110	5/3	

S30 Standard 							
	Maximum Fork Height		Overall Height ¹ Lowered		Free Lift ³		Standard Tilt Spec ² B°/F°
	in	mm	in	mm	in	mm	
83	2120	62.6	1590	4.3	110	6/10	
117	2980	79.5	2020	4.3	110	8/10	
• 130	3300	85.8	2180	4.3	110	10/8	
138	3500	91.3	2320	4.3	110	10/8	
147	3725	97.2	2470	4.3	110	10/8	
152	3860	100.2	2545	4.3	110	10/8	
164	4165	110.8	2815	4.3	110	5/6	
172	4380	118.7	3015	4.3	110	5/6	
182	4620	127.8	3245	4.3	110	5/6	
204	5170	138.2	3510	4.3	110	5/3	

S35 Standard 							
	Maximum Fork Height		Overall Height ¹ Lowered		Free Lift ³		Standard Tilt Spec ² B°/F°
	in	mm	in	mm	in	mm	
78	1985	63.4	1610	4.5	115	6/10	
112	2845	80.3	2040	4.5	115	8/10	
• 125	3165	86.6	2200	4.5	115	10/8	
132	3365	92.1	2340	4.5	115	10/8	
141	3590	98.0	2490	4.5	115	10/8	
147	3725	101.0	2565	4.5	115	10/8	
159	4030	111.6	2835	4.5	115	5/6	
167	4245	119.5	3035	4.5	115	5/6	
177	4485	128.5	3265	4.5	115	5/6	
198	5035	139.0	3530	4.5	115	5/3	

S20/25 Triple Stage 							
	Maximum Fork Height		Overall Height ¹ Lowered		Free Lift ³		Standard Tilt Spec ² B°/F°
	in	mm	in	mm	in	mm	
• 170	4320	78.9	2005	30.9	786	5/6	
177	4500	81.3	2065	33.3	846	5/6	
189	4800	85.2	2165	37.2	946	5/6	
205	5210	90.7	2305	42.8	1086	5/3	
217	5520	96.7	2455	48.7	1236	5/3	
226	5740	99.6	2530	51.6	1311	5/3	
240	6100	105.9	2690	57.9	1471	5/3	
251	6370	110.2	2800	62.2	1581	3/3	
269	6830	118.1	3000	70.1	1781	3/3	
288	7315	127.2	3230	79.2	2011	3/3	

S30 Triple Stage 							
	Maximum Fork Height		Overall Height ¹ Lowered		Free Lift ³		Standard Tilt Spec ² B°/F°
	in	mm	in	mm	in	mm	
170	4320	79.5	2020	31.5	801	5/6	
177	4500	81.9	2080	33.9	861	5/6	
• 189	4800	85.8	2180	37.8	961	5/6	
205	5210	91.3	2320	43.3	1101	5/3	
217	5520	97.2	2470	49.3	1251	5/3	
226	5740	100.2	2545	52.2	1326	5/3	
240	6100	106.5	2705	58.5	1486	5/3	
251	6370	110.8	2815	62.8	1596	3/3	
269	6830	118.7	3015	70.7	1796	3/3	
288	7315	127.8	3245	79.8	2026	3/3	

S35 Triple Stage 							
	Maximum Fork Height		Overall Height ¹ Lowered		Free Lift ³		Standard Tilt Spec ² B°/F°
	in	mm	in	mm	in	mm	
163	4140	80.3	2040	32.3	821	5/6	
170	4320	82.7	2100	34.7	881	5/6	
• 182	4620	86.6	2200	38.6	981	5/6	
198	5030	92.1	2340	44.1	1121	5/6	
210	5340	98.0	2490	50.0	1271	5/3	
219	5560	101.0	2565	53.0	1346	5/3	
233	5920	107.3	2725	59.3	1506	5/3	
244	6190	111.6	2835	63.6	1616	5/3	
262	6650	119.5	3035	71.5	1816	3/3	
281	7135	128.5	3265	80.6	2046	3/3	

- Indicates preferred common specification.
 - 1 For overall height raised with load backrest, add 48 in. (1220 mm) to maximum fork height.
 - 2 Standard tilt shown. Contact CLARK representative for information on optional tilt.
 - 3 Freelif dimensions shown are without load backrest.
- Other uprights available, contact a Clark representative.

Notes
 Production engines and driveline components may vary in output and/or efficiency by ±5%. The performance shown represents nominal values which may be obtained under typical operating conditions of a machine.

Upright Table

	Maximum Fork Height		Overall Height ¹ Lowered		Free Lift ³		Standard Tilt Spec ² B°/F°
	in	mm	in	mm	in	mm	
S20/25 Hi-Lo 							
115	2935	78.9	2005	30.9	786	6/8	
• 128	3255	85.2	2165	37.2	946	6/8	
139	3530	90.7	2305	42.8	1086	6/8	
148	3760	96.7	2455	48.7	1236	6/8	
154	3910	99.6	2530	51.6	1311	6/8	

S30 Hi-Lo 							
	Maximum Fork Height		Overall Height ¹ Lowered		Free Lift ³		Standard Tilt Spec ² B°/F°
	in	mm	in	mm	in	mm	
115	2935	79.5	2020	31.5	801	6/8	
• 128	3255	85.8	2180	37.8	961	6/8	
139	3530	91.3	2320	43.3	1101	6/8	
148	3760	97.2	2470	49.3	1251	6/8	
154	3910	100.2	2545	52.2	1326	6/8	

S20/25/30 Quad 							
	Maximum Fork Height		Overall Height ¹ Lowered		Free Lift ³		Standard Tilt Spec ² B°/F°
	in	mm	in	mm	in	mm	
• 240	6100	85.2	2165	37.2	946	5/3	
258	6560	90.9	2310	43.0	1091	3/3	
276	7015	97.0	2463	49.0	1244	3/3	
294	7480	103.0	2616	55.0	1397	3/3	
312	7935	109.0	2768	61.0	1549	3/3	

S30 Quad 							
	Maximum Fork Height		Overall Height ¹ Lowered		Free Lift ³		Standard Tilt Spec ² B°/F°
	in	mm	in	mm	in	mm	
• 240	6100	85.8	2180	37.8	961.0	5/3	
258	6560	91.5	2325	43.5	1106	3/3	
276	7015	97.6	2478	49.6	1259	3/3	
294	7480	103.6	2631	55.6	1412	3/3	
312	7935	109.6	2783	61.6	1564	3/3	

S35 Quad 							
	Maximum Fork Height		Overall Height ¹ Lowered		Free Lift ³		Standard Tilt Spec ² B°/F°
	in	mm	in	mm	in	mm	
• 240	6100	86.6	2200	38.6	981	5/3	
258	6560	91.5	2325	44.3	1126	3/3	
276	7015	97.6	2478	50.4	1279	3/3	
294	7480	103.6	2631	56.4	1432	3/3	
312	7935	109.6	2783	62.4	1584	3/3	

Grade Clearance 		
Model	A%	B%
S20	60.1	42.0
S25	50.0	42.0
S30	57.7	46.8
S35	57.7	48.6

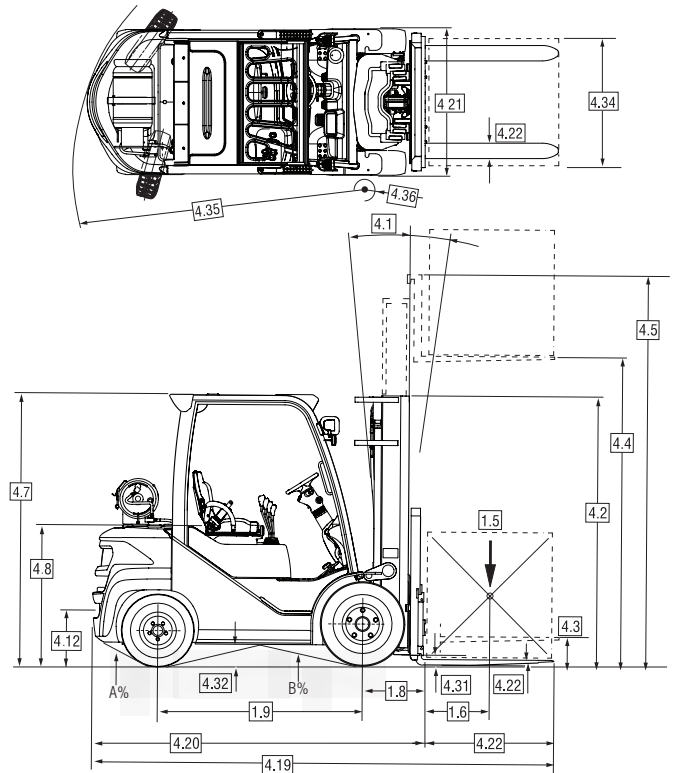

For corresponding data see Specification Chart

Standard Specifications S-Series Pneumatic Isuzu Diesel Engine



		S-Series ISUZU Tier4				
		S20D	S25D	S30D	S35D	
Specifications	1.1	Manufacturer				
	1.2	Manufacturer's designation	S20D	S25D	S30D	S35D
	1.3	Drive unit Diesel, L.P. Gas	Diesel	Diesel	Diesel	Diesel
	1.4	Operator type stand on / driver seated	Driver Seated	Driver Seated	Driver Seated	Driver Seated
Weight	1.5	Load capacity / rated load	lbs(kg) 4000 (2000)	5000 (2500)	6000 (3000)	7000 (3500)
	1.6	Load center distance	in(mm) 24 (500)	24 (500)	24 (500)	24 (500)
	1.8	Load center distance, center of drive axle to fork face	in(mm) 18.3 (465)	18.3 (465)	18.7 (475)	19.5 (495)
Tires	1.9	Wheelbase	in(mm) 65.0 (1650)	65.0 (1650)	66.9 (1700)	66.9 (1700)
	2.1	Service weight	lbs(kg) 7,573 (3435)	8,320 (3774)	9,354 (4243)	10,252 (4650)
	2.2	Axle loading, loaded front / rear	lbs(kg) 10,452 / 1,533 (4740 / 695)	12,046 / 1,786 (5463 / 810)	13,922 / 2,048 (6314 / 929)	15,759 / 2,212 (7147 / 1003)
Dimensions	2.3	Axle loading, unloaded front / rear	lbs(kg) 3,462 / 4,112 (1570 / 1865)	3,310 / 5,012 (1501 / 2273)	3,515 / 5,843 (1594 / 2650)	3,524 / 6,730 (1598 / 3052)
	3.1	Tire type, P = pneumatic, SE = solid pneu ¹	P	P	P	P
	3.2	Tire size, front	7.00x12-14PR	7.00x12-14PR	28x9x15-14PR	250x15-20PR
	3.3	Tire size, rear	6.00x9-10PR	6.00x9-10PR	6.50x10-12PR	6.50x10-12PR
	3.5	Wheels, number front/rear (x = drive wheels)	2x / 2	2x / 2	2x / 2	2x / 2
	3.6	Tread, front	in(mm) 37.9 (964)	37.9 (964)	39.3 (999)	39.6 (1005)
	3.7	Tread, rear	in(mm) 38.2 (970)	38.2 (970)	38.2 (970)	38.2 (970)
	4.1	Tilt of upright/fork carriage, back / forward	deg. 10B / 8F	10B / 8F	10B / 8F	10B / 8F
	4.2	Height, upright lowered	in(mm) 85.2 (2165)	85.2 (2165)	85.8 (2180)	86.6 (2200)
	4.3	Freelift	in(mm) 4.3 (110)	4.3 (110)	4.3 (110)	4.5 (115)
	4.4	Lift height ²	in(mm) 130 (3300)	130 (3300)	130 (3300)	125 (3165)
	4.5	Height, upright extended ⁶	in(mm) 154.5 (3924)	154.5 (3924)	156.2 (3967)	154.1 (3913)
	4.7	Height overhead guard	in(mm) 85.2 (2165)	85.2 (2165)	85.8 (2180)	86.6 (2200)
	4.8	Seat height	in(mm) 45.6 (1157)	45.6 (1157)	46.1 (1172)	46.1 (1172)
	4.12	Coupling height	in(mm) 16.1 (410)	16.1 (410)	16.7 (425)	16.7 (425)
	4.19	Overall length	in(mm) 143.3 (3639)	146.1 (3710)	151.2 (3840)	154.3 (3920)
	4.20	Length to face of forks	in(mm) 101.1 (2569)	103.9 (2640)	109.1 (2770)	112.2 (2850)
	4.21	Width_Tires	in(mm) 45.7 (1160)	45.7 (1160)	48.1 (1220)	48.9 (1242)
	4.22	Fork dimensions	in(mm) 1.75x4x42 (45x100x1070)	1.75x4x42 (45x100x1070)	1.75x4.8x42 (45x122x1070)	2.0x5x42 (50x125x1070)
4.23	Fork carriage, ITA	CLASS II	CLASS II	CLASS III	CLASS III	
4.24	Fork carriage width	in(mm) 41 (1041)	41 (1041)	41 (1041)	45.1 (1145)	
4.31	Ground clearance minimum, loaded	in(mm) 5.3 (135)	5.3 (135)	5.9 (150)	6.7 (170)	
4.32	Ground clearance center of wheelbase	in(mm) 6.1 (155)	6.1 (155)	6.7 (170)	6.7 (170)	
4.34	Right Angle Stack (Add Load Length and Clearance)	in(mm) 107.5 (2730)	110 (2795)	115.2 (2925)	118 (2997)	
4.35	Turning radius (truck)	in(mm) 89.2 (2265)	91.7 (2330)	96.5 (2450)	98.5 (2502)	
4.36	Inside turning radius	in(mm) 29.2 (741)	29.2 (741)	29.6 (751)	29.6 (751)	
Performance	5.1	Travel speed loaded / unloaded	mph(km/h) 10.3 (16.6) / 11.0 (17.7)	10.1 (16.3) / 10.9 (17.6)	10.9 (17.5) / 11.5 (18.6)	11.8 (19) / 12.0 (19.3)
	5.2	Lift speed loaded / unloaded	fpm(m/s) 108.2 (0.55) / 114.1 (0.58)	108.2 (0.55) / 114.1 (0.58)	108.2 (0.55) / 114.1 (0.58)	88.6 (0.45) / 94.5 (0.48)
	5.3	Lowering speed loaded / unloaded	fpm(m/s) 108.2 (0.55) / 98.4 (0.50)	108.2 (0.55) / 98.4 (0.50)	108.2 (0.55) / 98.4 (0.50)	92.5 (0.47) / 84.6 (0.43)
	5.6	Max. drawbar pull loaded / unloaded ^{3,4}	lbf(N) 5172 (23,006) / 1675.5 (7,453)	5214 (23,193) / 1583 (7,042)	4747 (21,116) / 1660 (7,384)	4354 (19,368) / 1660 (7,384)
	5.8	Max. gradeability loaded / unloaded ^{3,4}	% 47.6 / 23.2	40.7 / 20.2	31.1 / 19.0	25.0 / 17.5
5.10	Service brake	WET	WET	WET	WET	
Drive Line	7.1	Manufacturer / Type	ISUZU / 4LE2X	ISUZU / 4LE2X	ISUZU / 4LE2X	ISUZU / 4LE2X
	7.2	Rated output acc. to SAE J 1349	HP(kW) 61.7 (46)	61.7 (46)	61.7 (46)	61.7 (46)
	7.3	Rated speed	rpm 2400	2400	2400	2400
	7.4	No. of cylinders / displacement	/in ³ (cm ³) 4 / 133 (2179)	4 / 133 (2179)	4 / 133 (2179)	4 / 133 (2179)
8.2	Operating pressure for attachments	bar Adjustable	Adjustable	Adjustable	Adjustable	
8.4	Sound level, driver's ear ⁵	dB (A) 81	81	81	81	

1. Optional with solid tires
 2. Further lift heights see upright table
 3. Laden with 1.6 km/h

4. At friction coefficient $\mu=0.6$
 5. Equivalent permanent sound-pressure level L
 pAeq, T in accordance with DIN EN 12053

6. Without load backrest

Standard Specifications S-Series Pneumatic Ford L.P.Gas Engine



		S-Series L.P.Gas FORD Tier4				
1.1	Manufacturer					
1.2	Manufacturer's designation		S20L	S25L	S30L	S35L
1.3	Drive unit Diesel, L.P. Gas		L.P. Gas	L.P. Gas	L.P. Gas	L.P. Gas
1.4	Operator type stand on / driver seated		Driver Seated	Driver Seated	Driver Seated	Driver Seated
1.5	Load capacity / rated load	lbs(kg)	4000 (2000)	5000 (2500)	6000 (3000)	7000 (3500)
1.6	Load center distance	in(mm)	24 (500)	24 (500)	24 (500)	24 (500)
1.8	Load center distance, center of drive axle to fork face	in(mm)	18.3 (465)	18.3 (465)	18.7 (475)	19.5 (495)
1.9	Wheelbase	in(mm)	65.0 (1650)	65.0 (1650)	66.9 (1700)	66.9 (1700)
2.1	Service weight	lbs(kg)	7,363 (3340)	8,111 (3679)	9,147 (4149)	10,040 (4554)
2.2	Axle loading, loaded front / rear	lbs(kg)	10,595 / 1,177 (4806 / 534)	12,187 / 1,435 (5528 / 651)	14,050 / 1,711 (6373 / 776)	15,882 / 1,874 (7204 / 850)
2.3	Axle loading, unloaded front / rear	lbs(kg)	3,607 / 3,757 (1636 / 1704)	3,452 / 4,702 (1566 / 2133)	3,644 / 5,503 (1653 / 2496)	3,651 / 6,391 (1656 / 2899)
3.1	Tire type, P = pneumatic, SE = solid pneu ¹		P	P	P	P
3.2	Tire size, front		7.00x12-14PR	7.00x12-14PR	28x9x15-14PR	250x15-20PR
3.3	Tire size, rear		6.00x9-10PR	6.00x9-10PR	6.50x10-12PR	6.50x10-12PR
3.5	Wheels, number front/rear (x = drive wheels)		2x / 2	2x / 2	2x / 2	2x / 2
3.6	Tread, front	in(mm)	37.9 (964)	37.9 (964)	39.3 (999)	39.6 (1005)
3.7	Tread, rear	in(mm)	38.2 (970)	38.2 (970)	38.2 (970)	38.2 (970)
4.1	Tilt of upright/fork carriage, back / forward	deg.	10B / 8F	10B / 8F	10B / 8F	10B / 8F
4.2	Height, upright lowered	in(mm)	85.2 (2165)	85.2 (2165)	85.8 (2180)	86.6 (2200)
4.3	Freelift	in(mm)	4.3 (110)	4.3 (110)	4.3 (110)	4.5 (115)
4.4	Lift height ²	in(mm)	130 (3300)	130 (3300)	130 (3300)	125 (3165)
4.5	Height, upright extended ⁶	in(mm)	154.5 (3924)	154.5 (3924)	156.2 (3967)	154.1 (3913)
4.7	Height overhead guard (cab)	in(mm)	85.2 (2165)	85.2 (2165)	85.8 (2180)	86.6 (2200)
4.8	Seat height	in(mm)	45.6 (1157)	45.6 (1157)	46.1 (1172)	46.1 (1172)
4.12	Coupling height	in(mm)	16.1 (410)	16.1 (410)	16.7 (425)	16.7 (425)
4.19	Overall length	in(mm)	143.3 (3639)	146.1 (3710)	151.2 (3840)	154.3 (3920)
4.20	Length to face of forks	in(mm)	101.1 (2569)	103.9 (2640)	109.1 (2770)	112.2 (2850)
4.21	Width_Tires	in(mm)	45.7 (1160)	45.7 (1160)	48.1 (1220)	48.9 (1242)
4.22	Fork dimensions	in(mm)	1.75x4x42 (45x100x1070)	1.75x4x42 (45x100x1070)	1.75x4.8x42 (45x122x1070)	2.0x5x42 (50x125x1070)
4.23	Fork carriage, ITA		CLASS II	CLASS II	CLASS III	CLASS III
4.24	Fork carriage width	in(mm)	41 (1041)	41 (1041)	41 (1041)	45.1 (1145)
4.31	Ground clearance minimum, loaded	in(mm)	5.3 (135)	5.3 (135)	5.9 (150)	6.7 (170)
4.32	Ground clearance center of wheelbase	in(mm)	6.1 (155)	6.1 (155)	6.7 (170)	6.7 (170)
4.34	Right Angle Stack (Add Load Length and Clearance)	in(mm)	107.5 (2730)	110 (2795)	115.2 (2925)	118 (2997)
4.35	Turning radius (truck)	in(mm)	89.2 (2265)	91.7 (2330)	96.5 (2450)	98.5 (2502)
4.36	Inside turning radius	in(mm)	29.2 (741)	29.2 (741)	29.6 (751)	29.6 (751)
5.1	Travel speed loaded / unloaded	mph(km/h)	10.7 (17.2) / 11.4 (18.3)	10.4 (16.8) / 11.3 (18.2)	11.2 (18.1) / 11.9 (19.3)	11.2 (18.1) / 11.6 (18.7)
5.2	Lift speed loaded / unloaded	fpm(m/s)	102.4 (0.52) / 106.3 (0.54)	102.4 (0.52) / 106.3 (0.54)	102.4 (0.52) / 106.3 (0.54)	84.6 (0.43) / 88.6 (0.45)
5.3	Lowering speed loaded / unloaded	fpm(m/s)	108.2 (0.55) / 98.4 (0.50)	108.2 (0.55) / 98.4 (0.50)	108.2 (0.55) / 98.4 (0.50)	92.5 (0.47) / 84.6 (0.43)
5.6	Max. drawbar pull loaded / unloaded ^{3,4}	lbf(N)	4762 (21,182) / 1751 (7,789)	4795 (21,329) / 1656 (7,366)	4361 (19,399) / 1742 (7,749)	4239 (18,856) / 1731 (7,670)
5.8	Max. gradeability loaded / unloaded ^{3,4}	%	44.2 / 24.8	37.6 / 21.4	28.8 / 20.3	24.6 / 18.5
5.10	Service brake		WET	WET	WET	WET
7.1	Manufacturer / Type		FORD / FORD2.5	FORD / FORD2.5	FORD / FORD2.5	FORD / FORD2.5
7.2	Rated output acc. to SAE J 1349	HP(kW)	69.7 (52)	69.7 (52)	69.7 (52)	69.7 (52)
7.3	Rated speed	rpm	2500	2500	2500	2500
7.4	No. of cylinders / displacement	/in ³ (cm ³)	4 / 152 (2488)	4 / 152 (2488)	4 / 152 (2488)	4 / 152 (2488)
8.2	Operating pressure for attachments	bar	Adjustable	Adjustable	Adjustable	Adjustable
8.4	Sound level, driver's ear ⁵	dB (A)	79	79	79	79

1. Optional with solid tires

2. Further lift heights see upright table

3. Laden with 1.6 km/h

4. At friction coefficient $\mu=0.6$

5. Equivalent permanent sound-pressure level L

pAeq, T in accordance with DIN EN 12053

6. Without load backrest



100 YEARS OF MATERIAL HANDLING INNOVATION

A Centennial is an important milestone which not only celebrates longevity, but testifies to the strength of the CLARK brand across generations. This is reflected in the more than one million lift trucks manufactured by CLARK Material Handling Company over the past 100 years. Even more powerful than the number of trucks built is the company's legacy of innovation. It began in 1917 when employees of CLARK Equipment Company constructed a simple three-wheeled shop buggy to haul sand and castings between buildings at their Buchanan, Michigan plant. The "Trutractor" as the shop buggy was named, became



the first internal combustion material handling truck and was a great success. The industrial truck was born and in the process CLARK developed the first hydraulic lift. Through the years, many extraordinary inventions followed, among them the nested I-beam upright, overhead guard and operator restraint system. The founding principles of Eugene B. Clark are still true: "Aim always to build the best; never be content with just as good." Today the company remains focused on a bright future and the technologies and trends driving the material handling industry around the world. One Purpose, One Brand, One Legacy, One Century.



CLARK MATERIAL HANDLING COMPANY
North American Headquarters
700 Enterprise Drive • Lexington, KY 40510
866-252-5275 • www.clarkmhc.com

S-SERIES S25 BROCHURE
59-894-0348 Printed in USA OTP01185M
© 2017 CLARK Material Handling Company