

GRAIN HARVESTING

Combines and front end equipment



JOHN DEERE



It's time to Harvest. Smarter.

The S-Series has a long history of harvesting excellence, and that tradition continues with the S700 Series Combines. We've kept everything you love about the S-Series and made it even better by adding smart, integrated tools so you can harvest smarter.

Whatever the conditions or the operator, the S700 Series Combines automatically give you consistent grain quality. This gives you the confidence that your combine is compensating for changing conditions, even when you can't see them.

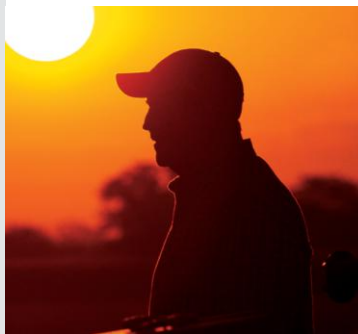



CONTENTS

S-Series Combines 4-5

Harvesting Precision Ag.....6-13

Cab / Controls..... 14-15

700C / FC Corn Heads 16-17

700FD HydraFlex Drapers 18-19

700D Drapers 20-21

600F / 615P Platforms22-23

Corn / Soybeans Solutions24

TriStream Rotor25

Small Grains Packages26

Variable Stream Rotor.....27

Cleaning Systems..... 28-29

Active Tailings System / Grain Handling.....30-31

Residue Management32-33

Transmission / Tracks..... 34-35

T670 Small Grain Combine 36-37

Engine38

Service / Support / Attachments..... 39-41

Specifications / Tracks / Tires.....42-43

Visit www.JohnDeere.com/Combines or www.JohnDeere.com/Combines for more details, or use the online product configurator to build and price a combine.

High-quality grain starts with an S-Series.



The S700 Combines are the result of engineering more innovation into your harvest:

- 2012** – Vari-Stream rotor
Premium cab
Premium residue system
- 2013** – 8-wing Feed Accelerator and Stone Trap (FAST)
- 2014** – Interactive Combine Adjustment
- 2015** – Active Concave Isolation
Feederhouse fore-aft platform tilt
- 2016** – DynaFlo™ Plus Cleaning Shoe
Active Terrain Adjustment
- 2018** – Combine Advisor™, ActiveYield™, 4600 CommandCenter display
- 2019** – John Deere Tracks, Remote View and Adjust

REDUCE SETUP TIME BY 10%

With the 4600 CommandCenter™ Display and Extended Monitor.

See page 14

INTEGRATED TECHNOLOGY

It's easier than ever to collect, view, analyze and share valuable data.

See pages 10-11

COMFORT AND CONTROL AT YOUR FINGERTIPS

With the redesigned CommandARM.

See page 14

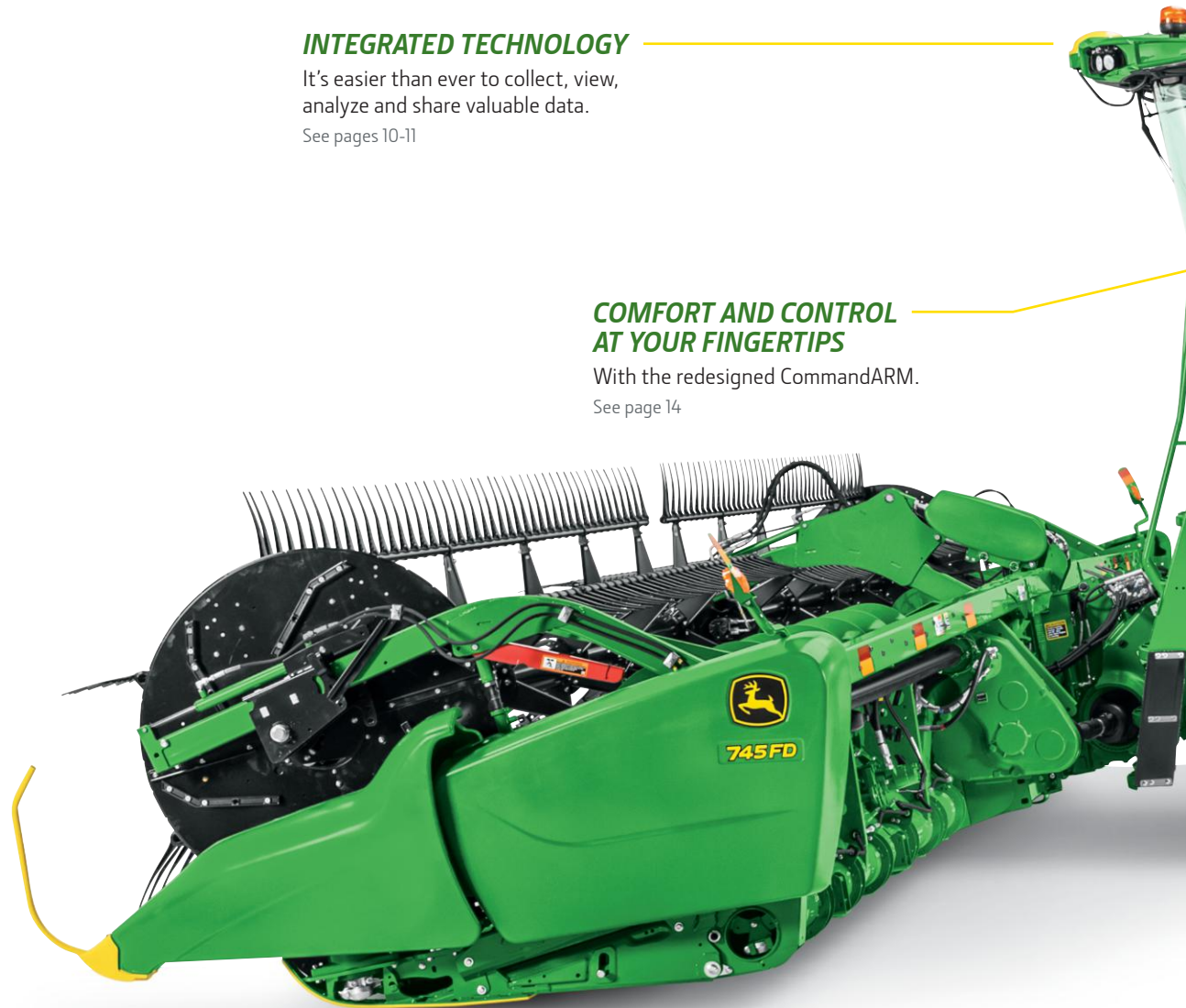



ELIMINATE MANUAL CALIBRATION

Save time with ActiveYield.
See page 8

REMOTE MANAGEMENT

Remotely view and adjust combine settings
with the MyOperations app
See page 11

HIGH QUALITY SAMPLE AND LOW LOSS

With the Combine Advisor package
with ActiveVision™ Cameras.
See page 7

Combine Advisor

Further improve grain quality and reduce losses with the new optional Combine Advisor package. It automatically compensates for changing conditions like wet straw and weeds, even if you can't see them. This package maintains the performance settings you choose — no matter the moisture or crop conditions. You can set it and forget it and your combine will continue to make adjustments as you harvest.

Set, optimize and automate your harvest:

- Harvest Setup
- VisionTrak
- Integrated Combine Adjust (ICA) Optimize Performance Wizard
- Active Terrain Adjustment™
- HarvestSmart™
- Auto Maintain
- ActiveVision™ Cameras



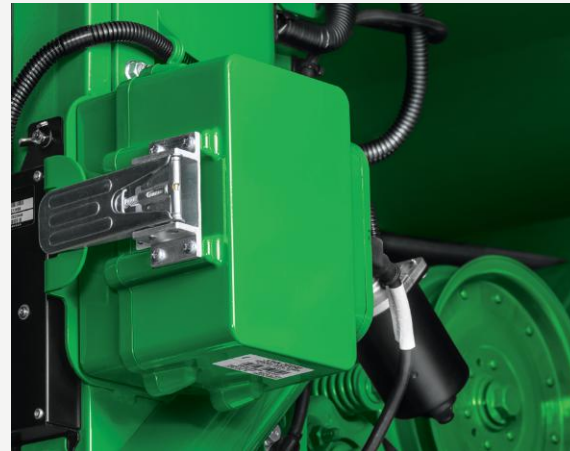

ActiveVision Cameras

Seeing is believing with the ActiveVision Cameras. Two cameras — one on the clean grain elevator and another on the tailings elevator — show grain samples in near-real time. A grain analysis feature shows grain quality and foreign material. You can have confidence the cameras, which work with Combine Advisor, are improving the grain sample, even on-the-go as conditions change.

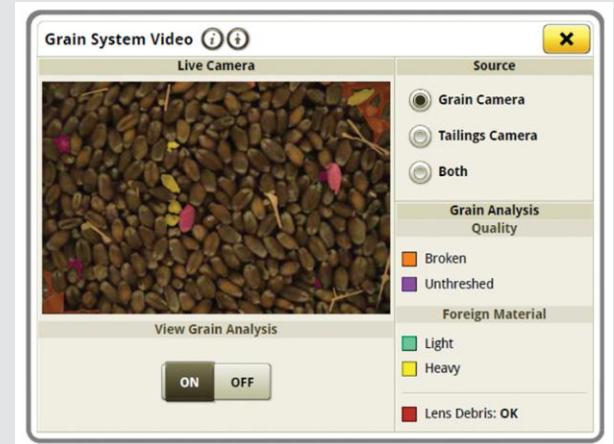

Save time spent calibrating

Manual calibrations can take up to 90 minutes, but with ActiveYield™, it's done with no time or effort away from harvest and will save you time, every day.

ActiveYield eliminates manual calibrations and replaces them with automated sensors that calibrate the machine by measuring the grain as the tank fills.

That means you can make decisions in real time — without leaving the cab. More importantly, it gives you more accurate yield mapping.

ActiveYield Retrofit Kit

The ActiveYield Retrofit Kit is available for the following combines*:

- BXE10797 for MY16 to the present is compatible with corn, soybeans, wheat, barley, and canola
- BXE10503 for MY12 to MY15 will be compatible with corn, soybeans, wheat, barley, and canola

** Not compatible with S660 or MY18 S760s with manual grain tank extensions.*



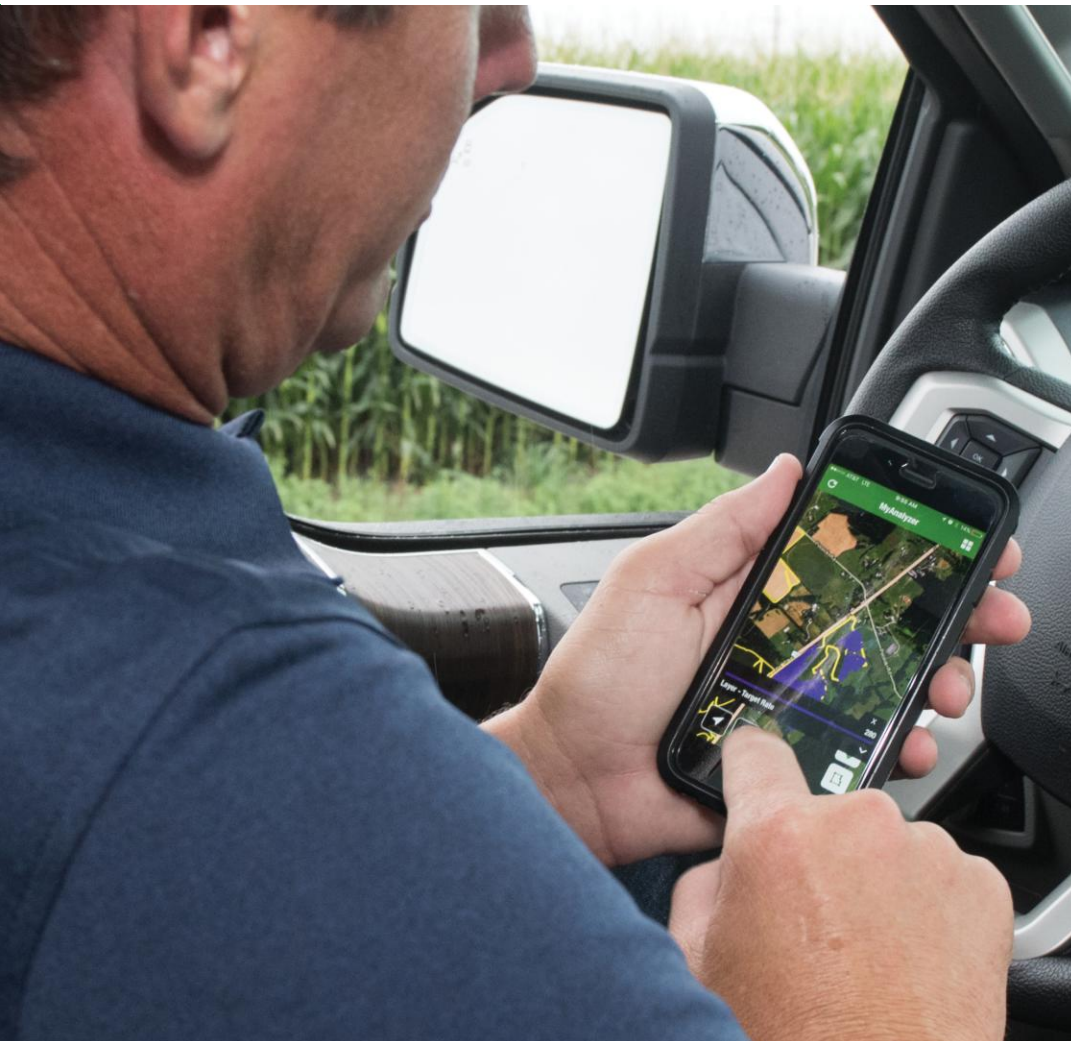

JDLink™ and John Deere Connected Support

Your S700 Combine comes with one year of JDLink Connect* at no cost and 5 years of John Deere Connected Support.

JDLink Connect opens an automatic, wireless information pipeline between you and your equipment. Agronomic data like yield maps and as-applied data can be accessed away from the field and shared with your advisors. And sending it from the field wirelessly and automatically can prevent you from losing data.

With John Deere Connected Support, you get Remote Display Access and Service ADVISOR™ Remote. You can monitor machine fuel levels, location history, receive alerts and even view the in-cab display remotely.

And if you do have issues, remote support is just a call away. Your dealer can monitor alerts, as well as diagnose problems or update software remotely to get you back up and running. You can view an operator's screen to resolve a setup issue or make changes during planting without going to the field. Downtime is also reduced when your dealer can remotely read diagnostic trouble codes.

**Activation/subscription required. Some additional accessories and/or components may be required. JDLink requires a cellular connection to transfer information from machine to JDLink website. Consult your local John Deere Dealer for coverage availability.*

Make next year's harvest even better

Your yield data will be more accurate than ever with your S700 Combine. But getting the best yield data is only useful if you can easily access and share it. That's where the John Deere Operations Center comes in. With it, you can turn your data into information that will make next year's harvest even better. Easily share your data with your agronomist, banker or seed rep.

With more than 75 software connected software tools, including the major farm management systems used by agronomists, Operations Center ensures you can choose to transfer your data to who you want and when you want.

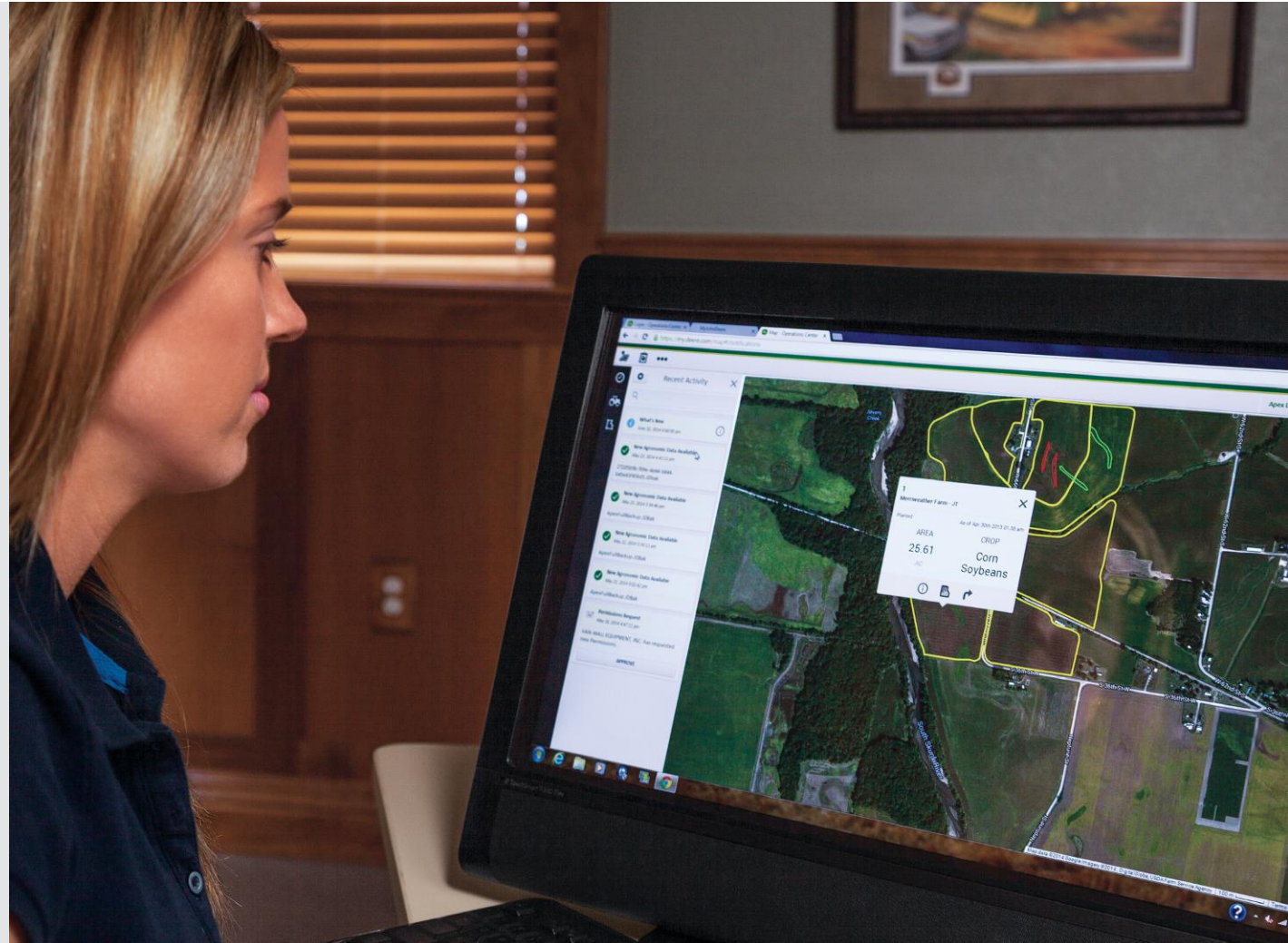



Like having your farm in your pocket

Sometimes you just need your information at your fingertips. Whether you're driving grain to the elevator or watching your kid's baseball game, you can get the information you need about your operation with our mobile apps.

MyOperations™

Manage your harvest from anywhere with the MyOperations app. Remotely view harvest information such as yield, moisture, and area worked. And you can now remotely view and adjust combine settings: concave clearance, rotor speed, fan speed, chaffer clearance, and sieve clearance. Plus, you can leverage historical map layers, as well as harvest summary information.

Connect Mobile

Being able to make decisions about next year's crop based upon an evaluation of this year's crop performance during harvest is a valuable tool. Connect Mobile lets you view two live maps for a single field so you can determine what worked well and what did not, all while harvesting.

Apps are available on iTunes® or Google Play™ store.

For the best harvest – just add guidance

No matter the crop, the AutoTrac* assisted steering system is the extra set of hands you need during harvest. With accuracy levels ranging from +/- 9 inches down to sub-inch, AutoTrac takes your harvesting efficiency to the next level. University research** shows automatic guidance pays for itself in 2 years or less. And when you add in how much better you feel at the end of a long, but hands-free day of harvesting, you'll know it's worth it. And starting with model year 2019, AutoTrac is included in base.

AutoTrac RowSense™

And for corn growers, AutoTrac RowSense delivers AutoTrac accuracy in down corn, around terraces or on pivots, by fusing GPS data from the StarFire™ Receiver with mechanical feeler data from the row sensors. AutoTrac RowSense improves harvest efficiency and yield quality, which lets you harvest at consistent speeds, even around curves.



* Activation required. Some additional accessories and/or components may be required.

** Auburn University, 2010.



Share and sync

With Machine Sync*, you get an impressive array of precision tools to help your harvest run more smoothly. To start, Machine Sync creates a network between a fleet of tractors and combines that helps automate on-the-go unloading by allowing the combine operator to control the movement of the tractor and grain cart. You also get in-field logistics like grain tank fill status and location of all combines and tractors in the network.

Machine Sync also gives you coverage map sharing and guidance line sharing, so you can easily see where another combine has already been and get a more accurate calculation of your yield acreage totals. And with guidance line sharing, multiple combines can share the same A-B line, reducing the time it takes to set coordinates.

**See your dealer for compatibility information.*

Comfort and control.

Our premium cab is the best place to spend long harvesting days. With excellent visibility to your header and crop, you also have everything you need to easily control your machine at your fingertips. The redesigned CommandARM, along with the new 4600 CommandCenter Display, delivers easy and intuitive harvest run screens. Shortcut buttons let you customize and quickly toggle between run pages. Plus, the Extended Monitor works with your 4600 display to give you more real estate for viewing.

The redesigned multifunction control lever fits your hand perfectly to give you smooth hydrostatic speed control. It also controls unloading operations, AutoTrac resume, and header functions.



If you want even more comfort, add the leather package option, equipped with leather steering wheel, lumbar-supported operator seat that is heated and ventilated, and leather instructor seat.





S-SERIES COMBINES CAB AND CONTROLS



Updated Bluetooth feature

Improved Bluetooth speaker delivers better mobile device functionality, keeping you hands-free and focusing on harvesting.



High standards

Not interested in the leather cab package? No problem. The standard comfort zone cab is still one of the highest in the industry. The air suspension swivel seat adjusts four ways to fit you perfectly. Lumbar adjustment gives you just the right amount of back support. There's even an optional heated cushion. And the seat swivels 15 degrees to the right and 7 degrees to the left for better grain tank and auger visibility.



Footpegs

Included with the premium cab, these footpegs deliver improved comfort during long harvest days.



More storage

Harvest time means long days in the field, which means you're working and eating on-the-go. Luckily the S-Series cab is big on space and storage. Plus, the integrated refrigerator keeps your refreshments cold all day.

Our Corn Heads excel in all conditions

700C/FC deliver a more productive harvest

You can't offer an incredibly powerful and productive combine and not deliver front-end equipment that can keep up with it. That's why we tag-teamed the S-Series with a full lineup of corn heads from 6 rows to 18 rows to meet a wide range of customer preferences. These corn heads perform exceptionally well at higher harvesting speeds, which means you can finish faster.

We know that more acres, higher yields and hybrids with tougher stalks are real challenges at harvest. That's why the 700C/FC components are robust enough to chop through the toughest, thickest crop with ease. High-performance gathering chains, stalk rolls, auger, and feederhouse promote smooth crop flow and help to make sure every kernel makes it inside the combine. The result? Fewer tossed ears, less ear shelling, and less trash fed through the combine.



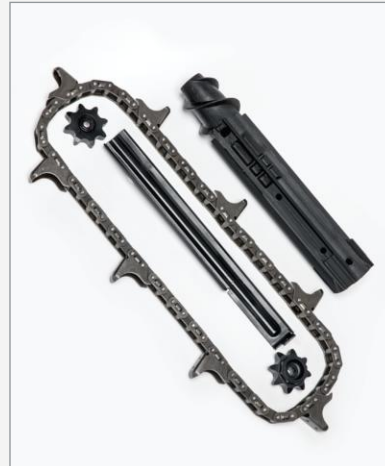

RowMax row units provide improved durability

The 700C/FC Corn Heads with RowMax deliver durability upgrades to gathering chains, gathering chain sprockets, chain guides, and stalk rolls.

Corn Heads equipped with RowMax deliver up to a 50% increase in wear life of row unit gathering chains and sprockets; the stalk roll wear life increases 25% with the new wear coating. RowMax is also available as a kit for 600C/FC Corn Heads.



Tapered shaft and locking retention nut improve retention and ensure optimal material transport. Stalks are drawn through with a gentle touch and then finely and consistently chopped by the StalkMaster chopper. The 700C/FC Corn Heads can also be tailored with stalk rolls designed to match your harvesting needs.

Straight fluted. Crimping action leaves the stalk mostly intact. (Available from your dealer)

Opposing Knife. Standard with StalkMaster to maximize stalk processing.

Intermeshing Knife. Medium stalk processing uses less power.

700C/FC StalkMaster™ Chopping Corn Heads



The StalkMaster Corn Head Chopping System lets you size and chop corn stalks while harvesting, eliminating second-pass operations and saving time, fuel, labor, and additional tractor operating costs. The difference between StalkMaster (right) and a standard corn head (left) is easy to see in the above photo; even easier to see in your fields. StalkMaster is available on the 706C, 708C, 712C, 716C, 718C, 708FC and 712FC Corn Heads.



Easy disconnect. The gearcase on the StalkMaster row units now features a chopping disconnect. Each row unit has a convenient shifting lever on the right side of the gearcase to turn the function on or off.

High-performance HydraFlex™ Drapers

How can you make sure you don't leave profit in the field? Get to know the true full-width flexible cutterbar – the 730FD, 735FD, 740FD, and 745FD HydraFlex Drapers. Covering a variety of platform sizes, the 30-ft, 35-ft, 40-ft, and 45-ft models flex 7.5 inches across the full width of the cutterbar allowing the draper to hug the ground, reaching more beans with every pass. Better still, the exclusive HydraFlex flotation system allows you to change the amount of weight of the cutterbar riding on the ground to match soft or hard soil conditions while you cut.



Our Dual-Position Feed Drum allows you to get greater crop versatility. For bushier crops, the 16-inch drum can be raised an inch for added throughput.



Keep an eye on what matters. We designed the 700FD Drapers with swept back rear panels that give you an unobstructed view across the full width of the head. You can see the crop as it's cut, laid head first on the side draper belts, delivered to the center belt, and fed smoothly into the combine.





On- and off-ground versatility

The 700FDs give you the ability to flex and get low-growing crops like soybeans and lentils in on-ground cutting. But if you also want smooth, fast feeding, and need off-ground cutting, the 700FD now offers a top crop auger for smoother feeding and controlling bushy crops in the feeding process, a center section seal kit to capture more grain at the center section, a dual-position drum to allow more space for throughput, and additional sensors for better off-ground height sensing.

And the new side draper belt system has a dual guide and a thicker, corrugated front edge. The symmetrical design allows you to flip the belts left to right — and top to bottom. Together, these features extend wear life by at least four times. Plus, we've made it faster than ever to remove and install belts.

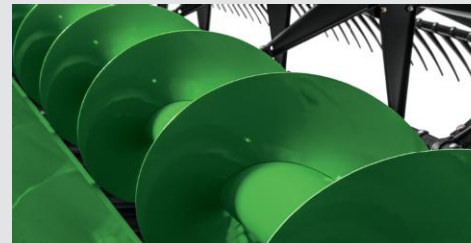

Draper Belt Protection System. Integrated into the HydraFlex draper platform, this system minimizes side belt damage should slippage occur. How does it work? Speed sensors monitor the speed of the idler rollers and if any major slippage happens, the belts shut off and a warning is displayed on the CommandCenter™ Display.



Reel Options. We equipped the 740FD and 745FD with two reels. The two-piece reel features a five-cylinder lift system that provides a consistently level reel height across the full width of the cutterbar. This allows even feeding of the crop onto the draper belts.

Side belt. Side belt speed reduction lets the operator slow down the side draper belts to a fixed speed with a push of a button. This feature is designed to improve draper performance when the operator is not harvesting the full platform width or when coming out of headlands.

Platform for success

The 700D drapers are designed to perform. The dual-knife drive system, with a built-in drive line protection system, provides years of trouble-free operation. Perma-Glide divider points are designed to minimize outer divider plugging. The optional 14-inch feed drum provides additional space for crop flow through the center feed section, which increases throughput in header limited conditions.

You also get more efficient feeding with the 18-inch top crop auger vs. the previous 12-inch auger. There's twice the hydraulic motor torque than the 2017 model. The increased slip clutch torque by 37.5% (1200 Nm to 1650 Nm) for the center feed section delivers a 20% reduction in slip clutch events.

With a complete draper line that includes sizes from 25 feet to 40 feet, John Deere offers the widest selection of draper heads for the widest range of crops and conditions.



- 1. Cutterbar Tilt.** A center-mounted hydraulic cylinder lets you tilt the cutterbar from the convenience of the cab using the advanced HydroHandle. You get the optimum cutting angle and the lowest possible cutting height.
- 2. Timed Dual-Knife Drive System.** You'll appreciate the smooth, vibration-free cutting performance you get from the shaft-driven in-line dual-knife drive system. Standard on the 730D, 735D and 740D.



18-inch top crop auger.

The 18 inch top crop auger is 50% larger than previous options. This helps to move bushy crops to the center section for smoother feeding. Combine this with the center section seal kit that reduces center section losses by up to 45% in canola for a winning combination in bushy crops.



Large gauge and transport wheels.

Get performance in the field and on the road with our 14-inch gauge wheels.

Unmatched flexibility

What's in front of your combine has just as much effect on productivity as what's inside your combine. So we designed the HydraFlex™ Platforms to match the high capacity of the S-Series Combines and equipped them with a range of performance-boosting features, including:

Single-point hookup. All John Deere headers and platforms feature single-point hookup of electrical and hydraulic connections, as well as latchpin engagement.

Double-cut knives with heavy-duty drive. Four-inch double-cut knives give you cutting capacity and harvesting speed, while the epicyclic drive offers reliable, smooth performance.

HydraFlex technology. With HydraFlex, you can control how much of the cutterbar's weight is on the ground without affecting the ultra-low cutting height of this header. Custom cutters can dial up the pressure to maximum, locking the cutterbar into the rigid position, thus giving you one platform you can use for wheat and beans.

Exclusive HydraFlex Platforms give you unmatched flexibility to run faster and cut cleaner over uneven ground. Float arms with hydraulic cylinders give you six inches of float, even when changing pressure to match harvest conditions. In-cab controls let you make adjustments, or run on "automatic." For rigid operation, simply use the maximum pressure, or use mechanical lock-out brackets.



The 26-inch diameter auger, with its 5-inch flighting, takes in a thick crop mat. Plus, long, retractable fingers running in-line the full width of the auger aggressively grab crop material once it's cut. Result: smooth, high-volume crop feeding – even at faster ground speeds.

The stone dam helps deflect rocks, minimizing damage, while helping hold material on the platform. Stainless steel deck plates provide a smooth transition between the cutterbar and auger. A short stone dam is standard on all HydraFlex platforms; a tall stone dam is available for rocky, uneven fields and no-till soybeans.

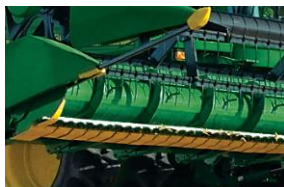

Segmented skid shoes (standard on HydraFlex platforms) provide more flexibility for ground-hugging harvests so you can reduce field losses in down or tangled crops.



Header height sensing helps maintain consistent off-ground cut height in uneven ground.



The heavy-duty epicyclic knife drive increases drive capacity and improves reliability. The straight-line oscillation makes the drive run smooth.



Smooth performance in windrows

No matter how rough the field or how thick the windrows, the 615P Belt Pick-Up gives you smooth, complete gathering of windrowed grain, thanks to a variety of exclusive features and innovations.

The 615P Belt Pickup will delight canola producers. Slug removal software improves the process used to take out slugs. By delaying the belt engagement after reversing the feederhouse, we've made harvesting even easier in challenging conditions.

Dual-belt draper pickup.

Increased belt pickup lengths deliver smoother material flow into the auger. And the added transfer belt moves crop under the auger for more controlled material handling in large, dense windrows.

Hydraulic adjustable windscreen.

Maximize productivity ... maintain crop. The windscreens allow you to adapt on the fly – all from the seat of your cab – to control crop flow into the pickup during changing windrow conditions.

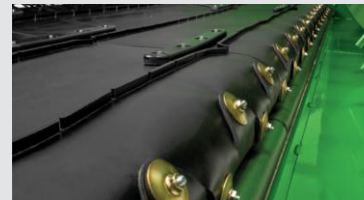

The exclusive **FieldGlide™** suspension features an adjustable air spring and heavy-duty hydraulic shock design to dampen movement during field operation and transport, allowing you to increase harvesting speed without bouncing the platform over windrowed crop. No tools required – simply set the air springs quickly and easily. Once set, the air springs don't need adjustment during the season.

High-capacity feeding for corn and beans

The **S-Series Combines** have a unique feederhouse design that gives you more than enough capacity to take full advantage of the extra productivity you get with these machines, and lets you handle the increased width and weight of the larger heads with ease and confidence.

The **feederhouse** on the S-Series provides large areas of clearance for high volumes of crop to flow uninterrupted, without hesitation. It's all about matched capacity. You can expect better engagement of crop, earlier, plus a smooth transition from corn head or platform to the feederhouse chain. The 5-speed feederhouse drives uses a high-torque slip clutch and 135-hp reverser, for more matched capacity.



What's an hour worth to you?

Better yet, what's several hours worth? Over the course of an entire harvest, an hour a day can really add up. With the convenient platform tilt option you can lengthen your harvest day by as much as an hour, and cut off significant time on the back end of the season.



Lateral tilt feederhouse – Take control of header tilt

Harvest more grain at faster speeds – in any terrain. The lateral tilt feederhouse is a self-leveling system that allows the feederhouse and header to tilt 4 degrees side-to-side, hugging the hills. Sensors on all platforms and corn heads detect changes in the terrain and signal the lateral tilt controller. Tilt response is instantaneous.

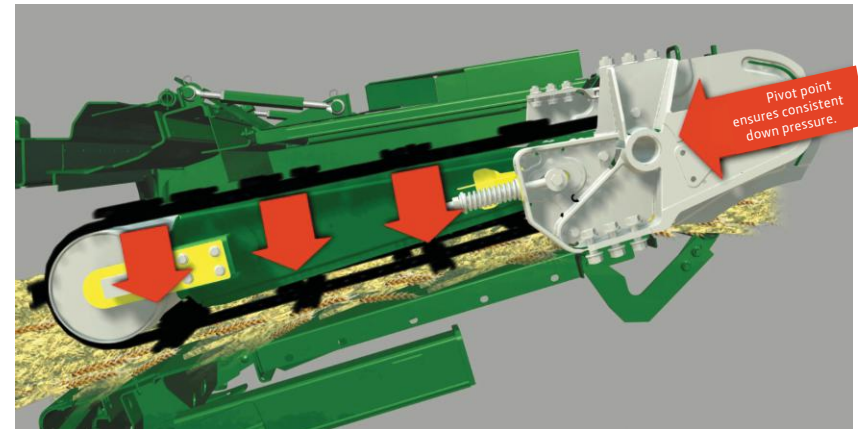

- **High-capacity feederhouse.** Provides a productivity boost for your John Deere S-Series Combine.
- **5-Speed Feederhouse Drive.** The durable high-torque slip clutch ensures peak performance and a long life cycle.
- **Better visibility.** The long feederhouse design gives you a full view of the header and the height-of-cut without having to lean forward. You can also see the stubble height behind the header.
- **Feederhouse reverser.** The robust reverser makes light work of stubborn plugs.
- **Single-lever multi-coupler.** Hooking up headers doesn't get much easier than this.
- **Easy adjustments.** The front plate can be adjusted fore and aft to compensate for different tire sizes, crops, and conditions, ensuring easy transition from the header every time.

Smooth operation – TriStream™ Rotor

The best of both worlds....high capacity and gentle threshing. That's why the TriStream stands out to corn, soybean and small grain growers.

The TriStream Rotor features a slightly tapered front nose, which dramatically reduces the 'growling' that often comes with thick crops and heavy rotor loads. The spiral vanes surrounding the rotor guide the crop material through the feeding and threshing area, reducing hesitation and improving productivity.



Dual-range separator-drive gives you a wide range of speeds to match conditions. High range provides 380 to 1,000 rpm; low range offers 210 to 550 rpm. Shift one lever to change ranges.

TriStream Rotor Technology reduces the force required to move material through the combine by as much as 20 percent. This easier, smoother crop flow reduces the potential for rotor 'growling' at high feedrates, even in damp conditions. This is especially beneficial when harvesting early or late in the day, or any time conditions impair crop flow.

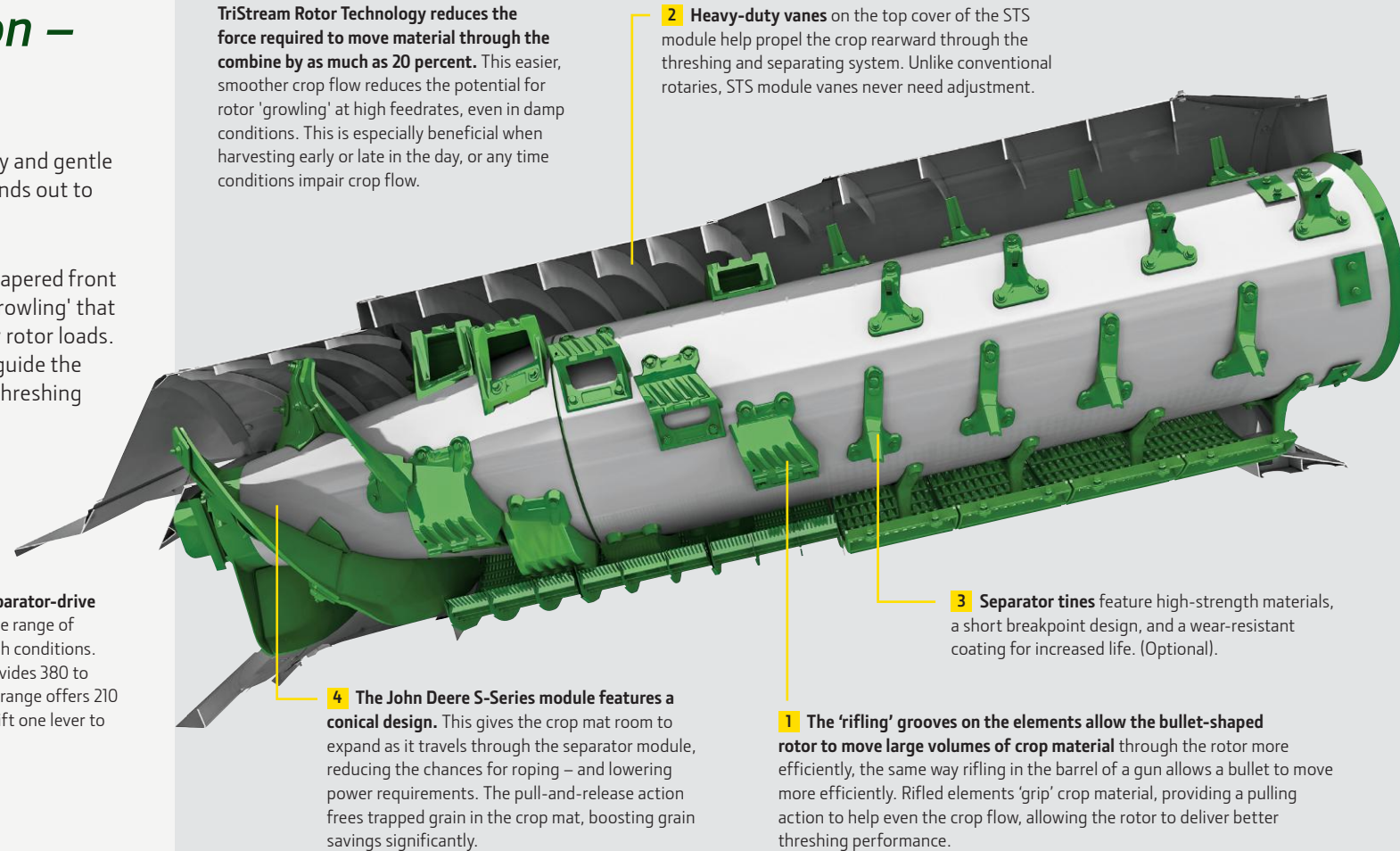

2 Heavy-duty vanes on the top cover of the STS module help propel the crop rearward through the threshing and separating system. Unlike conventional rotaries, STS module vanes never need adjustment.

3 Separator tines feature high-strength materials, a short breakpoint design, and a wear-resistant coating for increased life. (Optional).

1 The 'rifling' grooves on the elements allow the bullet-shaped rotor to move large volumes of crop material through the rotor more efficiently, the same way rifling in the barrel of a gun allows a bullet to move more efficiently. Rifled elements 'grip' crop material, providing a pulling action to help even the crop flow, allowing the rotor to deliver better threshing performance.

4 The John Deere S-Series module features a conical design. This gives the crop mat room to expand as it travels through the separator module, reducing the chances for roping – and lowering power requirements. The pull-and-release action frees trapped grain in the crop mat, boosting grain savings significantly.

Optional extended-wear separating package includes factory-installed extended-wear concaves, extended-wear threshing elements and separator tines, and extended-wear rotor top covers.

Raise your throughput by up to 20%

With tough small grains and rice packages

Truly tough conditions demand more than simple solutions. Rather than slightly improve performance in rice, canola, wheat, barley, oats or other tough small grains, we developed packages where your productivity will soar beyond current limitations — an increase of up to 20%.

How? Four crucial components – (1) Active Concave Isolation, (2) high-performance feederhouse, (3) heavy-duty separator grates with two rows of interrupter bars, and (4) 8-wing feed accelerator. Now, imagine a storm is on the radar and you don't have much time to spare. Thanks to this new package, you can go full throttle and still put your tough crop into the machine without any hiccups.



1 High-performance feederhouse

The front feed drum provides you with 2 inches of additional movement for greater flexibility when dealing with challenging crop.

2 Active Concave Isolation

In the past, concaves have all been mechanically suspended. Not any longer. Active Concave Isolation now applies hydraulic pressure to better secure the concave. This helps provide extra stability when harvesting really tough crops.

3 Heavy-duty separator grates (with interrupter bars)

Heavy-duty separator grates offer higher wear life and greater uptime for challenging conditions. And the dual-row interrupter bars help break up crop mat for superior separation.

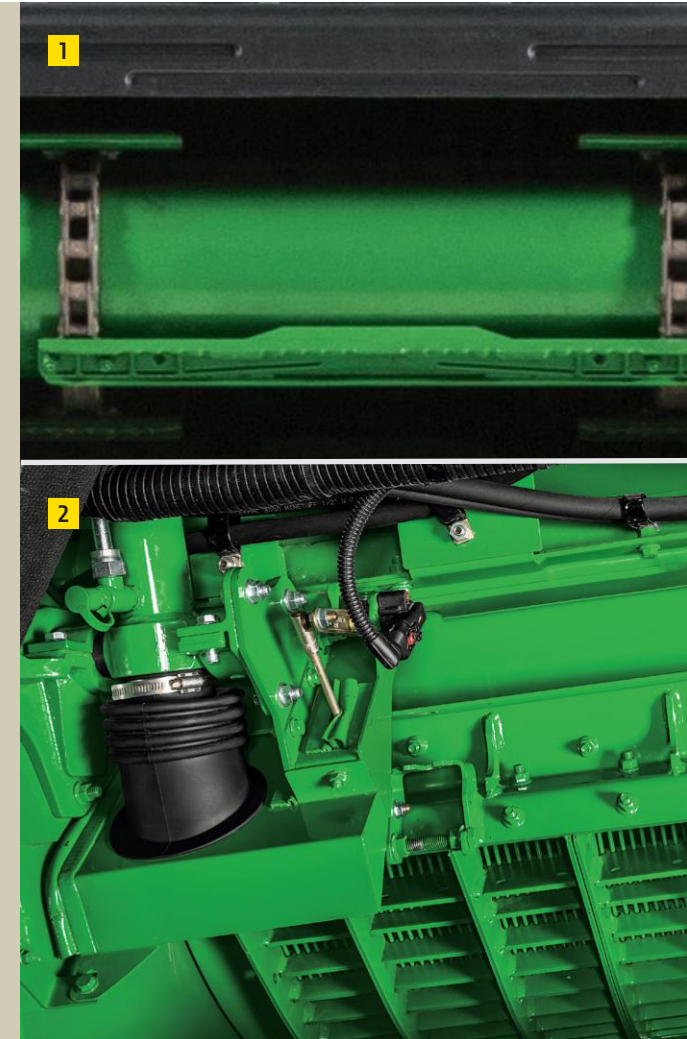

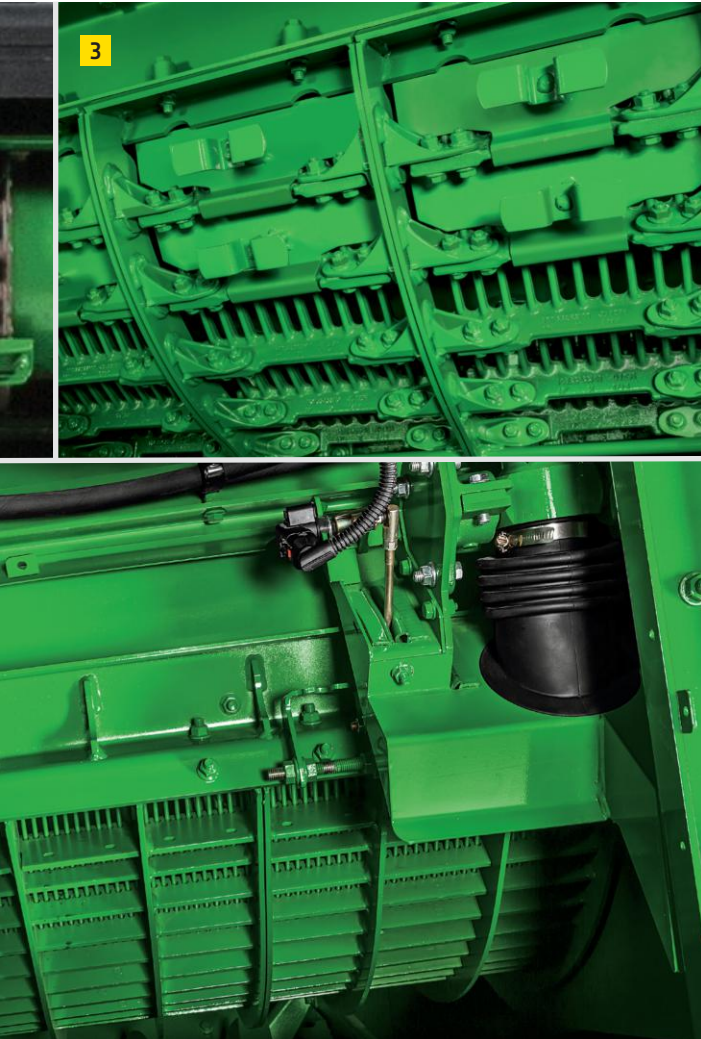

Variable Stream Rotor

Building on the proven performance of our TriStream rotor, we've added another opportunity for our small grain and rice operators – the Variable Stream rotor. It too delivers high capacity and smooth performance.

The longer, more tapered front cone design makes this rotor well-suited for rice, where conditions are damp, wet, or extremely green. The rotor is also recommended for small grains where straw is tough. The vane angle can be adjusted to reduce the stress on straw material as it flows around the rotor, increasing the quality of the straw.

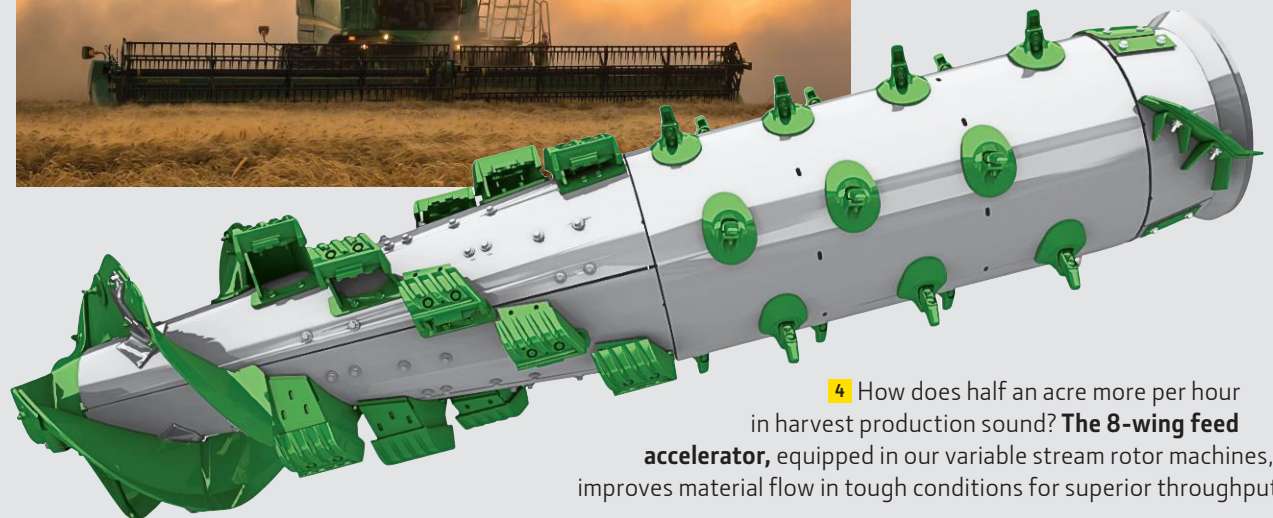

4 How does half an acre more per hour in harvest production sound? **The 8-wing feed accelerator**, equipped in our variable stream rotor machines, improves material flow in tough conditions for superior throughput.

Dyna-Flo™ Plus Cleaning Shoe

Consider your capacity needs met.

You want more cleaning capacity? We've got it with the S-Series. Lighter in weight and longer in sieve (12% increase in surface area since 2016), the Dyna-Flo Plus Cleaning Shoe improves capacity like you wouldn't believe.

In shoe-limited conditions, capacity is raised 10% in corn and 13% in wheat and canola. Also, thanks to the additional capacity, you get 1.5 acres per hour of added time. The Dyna-Flo Plus Cleaning Shoe also knocks down your tailings by as much as 28% to raise your overall speed and productivity. Simply put, this is a cleaning system that does it all.

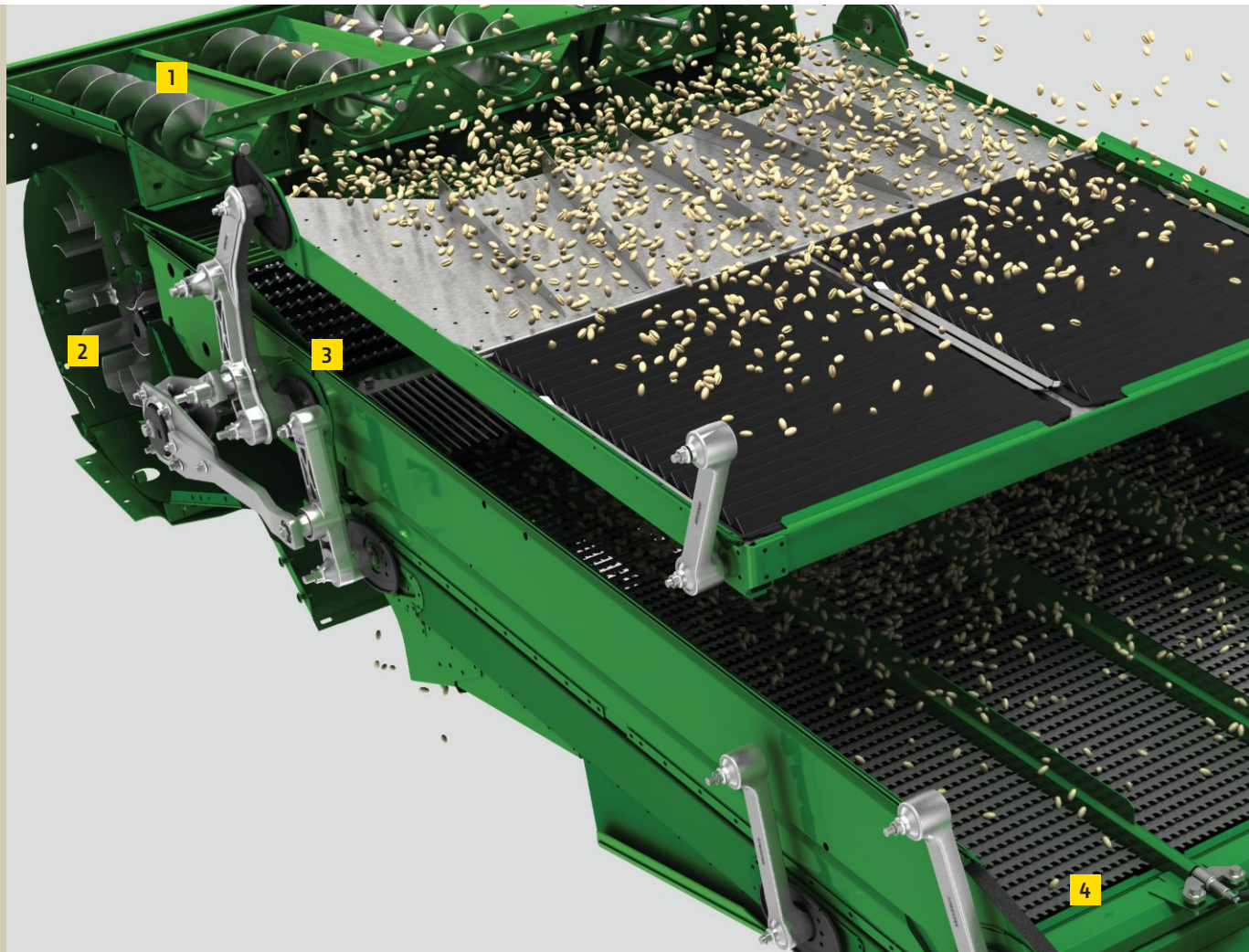



1 Uniform distribution

Four conveyor augers move material onto the shoe steadily and evenly, even on hillsides.

2 Improved fan performance

The fan ensures peak performance and a clean grain sample. A steep pressure curve delivers high pressure with less volume loss. About 30% of the air goes to the front chaffer at high speed; the rest goes to the rear chaffer and sieve.

3 Two-stage pre-cleaning

The fixed front chaffer helps thin the crop mat; the raised front chaffer pre-cleans up to 40% of the free grain before it reaches the main chaffer.

4 Extended design for more capacity.

The huge rear chaffer and bigger sieve are specially designed to handle the threshing and separating performance of the new S-Series.



The shoe drive features an improved belt that offers double the cross-section of our previous belt and provides twice the tensile strength to tackle the toughest harvesting conditions. For even greater durability and uptime, the bearings, pulleys, and supports have all been upgraded, as well.



The dual chaffer adjustment offers improved grain tank cleanliness and greater tailing performance.

Active Tailings System

Higher capacity with a gentle touch. If you run a large combine and work a lot of acres, then you'll appreciate the Active Tailings System on the S780 and S790 models. By handling returns that might normally go back to the separator, consuming its performance, it distributes the grain and material back onto the return pan, not to the threshing area, and increases the total capacity of your machine. Better still, it's easy to adjust. Our Active Tailings System uses less aggressive concave settings than the ones in your separator – and handles sensitive crops gently, maintaining grain quality.

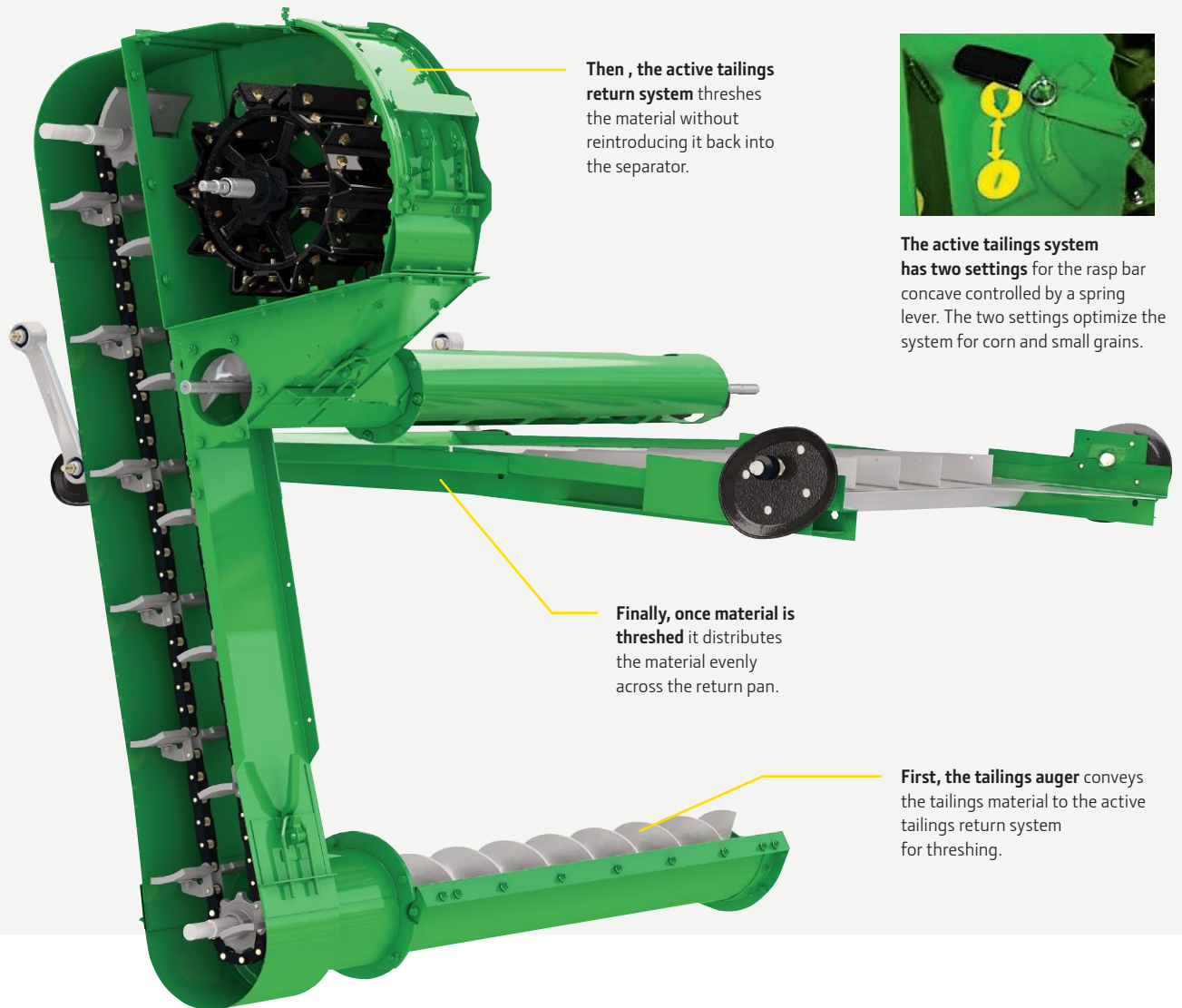
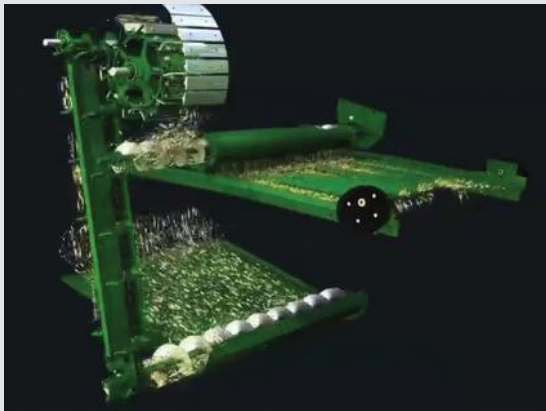

Then, the active tailings return system threshes the material without reintroducing it back into the separator.



The active tailings system has two settings for the rasp bar concave controlled by a spring lever. The two settings optimize the system for corn and small grains.

Finally, once material is threshed it distributes the material evenly across the return pan.

First, the tailings auger conveys the tailings material to the active tailings return system for threshing.



Grain handling capacity that keeps you running

High yields and tough schedules necessitate a clean grain handling system that can keep up with your harvesting pace. Here's how the S-Series Combines Dyna-Flo Plus Cleaning Shoe delivers:

400-bushel grain tank – Our S780 and S790 machines boast a 400-bushel capacity, in order to attain matched capacity with available front-end equipment.

Fast delivery – 105 seconds (that's 3.8 bushels/second) is all it takes to empty the 400-bushel grain tank that's standard on the S780 and S790.

Better handling – The optional 26-foot (7.9 m) rigid unloading auger pairs ideally with the 40-ft platforms and 18-row corn heads, making unloading on-the-go a stress-free operation. With the 28.5-ft unloading auger, we've extended reach by two and a half feet.

A different kind of cleaning system. While your cleaning shoe handles your grain, our on-board air compressor will keep the outside of your machine looking neat and like-new. Located in the engine compartment, the air compressor offers a quick and convenient way to keep your combine free of debris, which helps with the uptime of your machine.



Residue handling, made flexible

Chopped, dropped or fine-cut... the S-Series Combines feature residue handling systems and options that are designed to take care of your residue management needs.

The S-Series Combines feature a fine-cut chopper. The chopper blades, along with unique air shrouds in the chopper housing, give an ultra-fine cut while generating a strong blast of air for more even residue distribution.





The PowerCast™ tailboard provides an effective way to manage residue disposal on your wider platforms. PowerCast evenly spreads residue 30 to 45 feet to help with even crop emergence, especially in no-till farming. PowerCast is hydraulically powered and mounts to the rear of the chopper, but all you have to do is relax in your operator seat to set the speed of the system: it's controlled by a button on the CommandArm.

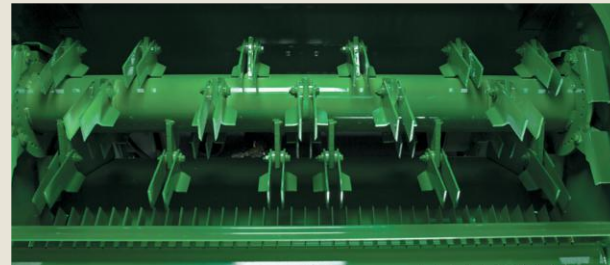

They also feature a manually adjustable vane tailboard design, perfect for spreading residue in widths to 30 feet (9.14 m). This system is easy to swing up and out of the way for windrowing.

Enhanced residue disposal



The Advanced PowerCast™ tailboard and straw chopper is an option of the premium residue system that gives you additional residue management flexibility. The Advanced PowerCast tailboard contains two hydraulically-driven enclosed discs and a center divider that moves back and forth in a pendulum motion. A straw chopper, overshot beater, and straw chute complete the premium residue system.

With the premium residue system you can:

- Chop straw and chaff, and then spread both by making adjustments within the cab
- Form a straw windrow while chopping and spreading chaff
- Form a straw and chaff windrow without chopping material
- In-cab shroud adjustment for wind compensation





The ProDrive™ Ground Drive System

Get more precise, more consistent control of your ground speed throughout the travel range of the hydro handle. ProDrive lets you switch between two infinitely variable speed ranges with the push of a button. Using the CommandTouch™ armrest console, set the first range for typical harvesting speeds, and the second for transport.

It reduces your combine's engine RPMs during transport while still maintaining a productive ground speed. The results? Improved fuel savings, helping you increase fuel efficiency.



Another benefit ProDrive delivers: An electro-hydraulic differential lock with a 4-pinion differential for greater traction in muddy harvesting conditions.

The right transmission for you

ProDrive: Automatic efficiency

Seamless shifting. When ground conditions change, ProDrive lets you smoothly shift between two speed ranges with the push of a button. You'll no longer have to stop to shift when going up or down hills or exiting fields.

Speed Selection. Set one speed for normal harvesting, the other for faster field work or transport. Then select any speed in either range by using the hydrostatic control handle on your CommandARM™ console.

More torque. With power to spare, ProDrive makes light work of tough conditions. It delivers 64% more torque at a harvesting speed of 5 mph (8 km/h).

Push Button Shift Transmission

Shifting made easy. Our three-speed Push Button Shift Transmission makes shifting easy. Simply bring your machine to a standstill, select the gear you need by pressing one of three buttons on the arm rest and let the combine do the rest.

Comfort and control. Our Push Button Shift Transmission makes operation easier with features like the automatic park brake. As soon as you pull the hydro level to the neutral position, the park brake is applied giving you more comfort and control and helping you through those long working days.

Two-speed 4-wheel-drive lets you switch between torque ranges. In slow-speed mode, the high-torque rear assist is ideal for tough conditions. Use high-speed mode for low-torque performance and faster ground speeds.



John Deere Tracks for S-Series Combines

Now your ability to get into your fields sooner is easier than ever. Reach a road transport speed of almost 25 miles per hour with new John Deere Tracks. The suspended track system provides a smoother ride with better ground following. This makes for more comfortable harvesting days and lets you finish faster.

These tracks — available with 30- or 36-inch wide belts — deliver better ride quality and ground following, thanks to new suspension cylinder and tandem bogie wheels.

The wider track footprint improves flotation and compaction — plus there's no daily maintenance.



The heavy-duty final drive is designed and manufactured with a massive, ductile iron housing that provides high load-carrying capability. The final drive provides the capacity to handle larger high-flotation tire options as well as wide draper platforms or large corn heads.



The hydrostatic system includes a variable displacement pump gear driven from the main engine gear case and a variable displacement motor located on the ProDrive™ Transmission. This provides an infinite speed range in each gear and eliminates ground belts, reducing maintenance.



All S-Series Combines feature adjustable rear axles that let you adjust tire tread from 120- to 152-inch centers (305-cm 386-cm) in 4-inch (102-mm) increments... ideal for ridge-tillage operations.

Time better spent

Harvest more acres per day with the T670 Combine

The T670 not only increases your productivity and efficiency, but also improves the quality of your grain and straw – and that’s something you can rely on in every situation. The proven crop flow system doesn’t bend or break your grain or straw and offers improved performance in all crops and all harvest conditions. The advanced threshing and cleaning systems now have the largest surface area of its kind on the market.

The T670 delivers up to 15% more capacity in wheat so you can work faster and more efficiently. And it comes ready to roll with precision ag technology.

Pair your T670 with a 700D HydraFloat(TM) Draper or 700FD HydraFlex(TM) Draper. The hydraulic height system on the 700D lets you increase pressure from the cab and the cutterbar will float over the ground without bulldozing.





New for 2018

The new 28.5-ft unloading auger matches front end equipment for improved unloading logistics. And for easy changing between crops, one person can now change the concave inserts through the stone trap, without removing the feederhouse.

On the separator, square edge bars have been replaced with rounded bars; eliminating the last three finger rows and extending wires to cover the same area. An LED lighting package is now available for the full machine. Plus, you can now drain hydraulic, PTO and engine oil from ground level.



Better performance and serviceability

The T670 features the largest cleaning shoe of its kind on the market, which enables ease of adjustment and delivers a more stable performance under changing harvesting conditions. With the Dyna-Flo™ Plus cleaning shoe, there are fewer manual and remote adjustments needed to be done by the operator. The new Dyna-Flo Plus cleaning system reduces tailings volume, particularly the amount of threshed grain in the tailings system.

The largest separator of its kind on the market features an unbeatably spacious separation area of 4m². The unique multi-drum threshing system with crops flowing above the overshot beater ensures a consistent crop flow without sharp bends or abrupt changes in direction. For the new T670, we have further extended the threshing concave by 8 degrees, but kept the same angles and interconnection points to ensure excellent grain and straw quality.

Improved serviceability means more time for harvest. With fewer maintenance intervals and improved access to service and maintenance points, you'll spend less time on service tasks. Plus, the T670 comes with an optional, factory-installed air compressor. A 16-gal (60L) air reservoir with a 33-foot (10m) hose and 3 air quick coupler points helps keep your combine clean.



Fast crop conversion. The time needed to reconfigure the T670 for optimum performance when changing crops has been reduced by the redesign of the T670 De-awning Plates (Front Concave Closure Plates) and concave Booster Bar. The three articulated plates close the front three concave bars for more intense threshing in hard-to-thresh crops and conditions where white caps are an issue. Positioning of the de-awning plates can be done quickly without the use of tools. Booster bar adjustment also can be done easily and quickly within minutes.

PowerTech™ PSS Engine: Built to the highest standards

Series turbochargers

Deliver higher power, more low-speed torque and engine responsiveness to meet varying load conditions.

Variable geometry turbocharger (VGT)

Electronic controls open or close variable vanes depending on load and speed. Optimized airflow generates more boost allowing for quicker load response, increased low-rpm torque, better transient response and improved fluid efficiency.

High-pressure fuel system

Enables precise control for start, duration and end of injection; controls fuel injection timing and provides higher injection pressures improving combustion, engine performance and reducing emissions.

Catalyzed exhaust filter with DOC/DPF

Exhaust gases flow through an oxidation catalyst and filter trapping particulate matter. During normal operating conditions the engine's natural heat oxidizes the trapped particulate matter and cleans the filter.

Cooled exhaust gas recirculation (EGR)

Precise amounts of cooled exhaust gases are mixed with incoming fresh air lowering combustion temperatures. This improves performance and lowers emissions.

Selective catalytic reduction (SCR)

This technology utilizes a urea based additive referred to as diesel exhaust fluid (DEF). The ammonia in the urea mixes with engine exhaust gases in the SCR catalyst to reduce NOx. The optimization of cooled EGR and SCR allows John Deere machines to use less DEF than other FT4 solutions.

Air-to-air aftercooling

Lowers the intake manifold air temperature promoting more efficient cooling and greater engine reliability.



S-Series 13.5 Liter Engine

S-Series 9.0 Liter Engine





The John Deere dealership promise: Standard with every piece of equipment we sell

You can't see it and you can't order it, but the John Deere dealership promise comes with your combine to keep it running smoothly all season long. Take a look:

We promise to support your combine with a powerful dealer network that stretches across all of North America.

We promise to have trained parts and service technicians who can help you reduce your downtime and maintenance costs.

We promise to quickly diagnose and repair your combine through the use of the latest technology.

We promise parts support through our in-stock parts inventory, as well as with JDParts.com.

S-Series Combines let you breeze through your service and maintenance schedules ... starting with accessibility. Gas struts on the side shields allow them to virtually lift on their own, without any heavy lifting. Service and maintenance points are easy to locate, too, thanks to an uncluttered layout. You can view everything from the separator and cleaning shoe (left side) to the tailings and clean-grain elevators (right side). Greasing the lube banks are easy, as well. Or choose the automatic grease option. Bottom line: service less, harvest more.



Looking to squeeze more production out of the day?

+ Add More

There's more to your combine than you know. How much more? Well, that depends. What are you looking to get out of each day, each crop, or each harvest? Whatever the answer, we can help.

Genuine and Guaranteed*

Your local John Deere Dealer offers a comprehensive parts inventory, highly-trained service technicians, and the expertise to help you get the most out of your equipment investment. And now, John Deere O.E. M. agricultural parts installed by an authorized John Deere Dealer carry a 12-month, unlimited-hour warranty including labor. If you prefer to handle repairs yourself, all Genuine John Deere ag and turf parts sold carry a 6-month warranty.



Grain Tank Mirror Kit

Add grain tank mirrors for improved visibility of the fill level in the grain tank.

- KXE10458 – fits all harvesting cabs MY12-present



Sidehill Performance Kit

Improve combine performance on sidehill slopes up to 8° (14%) by reducing cleaning shoe grain loss to acceptable levels. Kit includes tall chaffer dividers, exclusive grain agitators, and grain pan diverters.



In-Cab Mobile Devices Mounting Brackets

We've made it easier and more convenient for you to have hands-free access and improved viewing of your iPad, iPhone, or other mobile device from the seat of your cab. They're easily accessible and don't interfere with visibility and machine controls. Even better, they're customizable to fit your specific cab needs.

Additional Grain Tank Sensor

The fast easy way to let you know when your combine's grain tank is full when harvesting on sidehills.



ActiveYield Retrofit Kit

ActiveYield is available for five crops: corn, soybean, wheat, canola and barley. Kits are not compatible with S660 with manual fold extensions or MY18 S760s with manual fold extensions.

- BXE10503 for MY12-15
- BXE10797 for MY16+





700C/FC RowMax™ Row Unit Service Kits

Increase wear life of sprockets and gathering chains by 50%, increase wear life of stalk rolls by 25%

- KXE10487 – Factory base on 700C/FC; available for retrofit on MY12 and newer 600C/FC's
- Stalk rolls should also be ordered



600D, 700D and 700FD Center Section Seal Kit

The center section seal kit minimizes grain loss when direct cutting canola. Reduce center feed section losses on 600D, 700D and 700FD drapers by 45%. For the best performance when harvesting cereal grains, it is recommended to remove the left and right side seal components.



Foot Pegs

- KXE10454 – Foot peg upgrade kit for improved comfort
- Base equipment with premium cab



700D Top Crop Auger Bundles

Smoother feeding in tough crop conditions due to a 50% increase in top crop auger diameter and twice the torque on the top crop auger motors.

Voyager Camera Ready Options

Cameras bundles are available for MY17 and newer combines

- SWVCMS155B – Camera
- SWVCMS155JD1 – One camera kit
- SWVCMS155JD3 – Three camera kit

Sometimes the best new addition to your fleet isn't new

JOHN DEERE
CERTIFIED
PRE-OWNED

If you've ever considered purchasing a used combine, this is the ideal time. Besides the impressive fuel economy, comfort, convenience and

technology found on all John Deere combines, the value that comes with purchasing a John Deere Certified Pre-Owned machine is hard to ignore. Every CPO Combine is covered by a one-year Comprehensive PowerGard™* plan, giving you the coverage benefits of new, with the extra value of pre-owned.

Right now, no one else offers a low-hour combine that's been field tested, inspected and certified on over 200 points. Top to bottom, front to back, everything from engine performance to wiper blades is put to the test and thoroughly examined by a John Deere Certified Technician. Add to that a free year of JDLink™† and a John Deere Certified Pre-Owned combine deserves even more of your attention. New or new-to-you, Nothing Runs Like A Deere.™

* See the PowerGard Protection Plan contract for all terms, conditions, limitations and exclusions.

† Activation/subscription required. Some additional accessories and/or components may be required. JDLink requires a cellular data connection to transfer information from machine to JDLink website. Consult your local John Deere Dealer for coverage availability.

S-SERIES COMBINES SPECIFICATIONS

MODEL	S760	S770	S780	S790	T670
ENGINE					
Type	John Deere 6 cyl. 9.0 L	John Deere 6-cyl. 9.0 L	John Deere 6-cyl 13.5 L	John Deere 6-cyl 13.5 L	John Deere 6 cyl. 9.0 L
Displacement (L/cu. in.)	9.0/548	9.0/548	13.5/824	13.5/824	548 cu. in (9.0L)
Fuel Capacity (L/gal.)	950/250	950/250	1250/330	1250/330	800/211
Cooling	Air-to-Air Aftercooler	Air-to-Air Aftercooler	Air-to-Air Aftercooler	Air-to-Air Aftercooler	Air-to-Air Aftercooler
Rated Speed (rpm)	2200	2200	2100	2100	2200
Rated Power (kW/hp) @ Rated Speed - T4	249/333	292/391	353/473	405/543	292/392
Power Boost @ Rated Speed (kW/hp) - T4	274/367	317/425	37/50	37/50	25/34
Rated Power @ -100 rpm Rated Speed (kW/hp) - T4	267/358	313/419	378/507	433/580	n/a
Peak Power @ -200 rpm Rated Speed (kW/hp) - T4	285/382	335/449*	402/540	460/617	n/a
Rated Power (kW/hp) @ Rated Speed ---NON-iT4	239/320	278/373	353/473	405/543	n/a
Power Boost @ Rated Speed (kW/hp) ---NON-iT4	25/34	25/34	37/50	23/31	n/a
Rated Power @ -100 rpm Rated Speed (kW/hp) ---NON-iT4	256/343	297/398	378/507	433/580	n/a
Peak Power @ -200 rpm Rated Speed (kW/hp) ---NON-iT4	272/365	317/425	402/540	458/614	n/a
FEEDING					
Drive Type	Fixed or Variable	Fixed or Variable or MultiSpeed	Fixed or MultiSpeed	Fixed or MultiSpeed	Fixed
Conveyor Chain Slat Type	Cast Iron	Cast Iron	Cast Iron	Cast Iron	Under shot-slat
Width (mm/in.)	1397/55	1397/55	1397/55	1397/55	--
Length (mm/in.)	1727/68	1727/68	1727/68	1727/68	1850/73
Feed Accelerator, Stone Trap (FAST)	Standard	Standard	Standard	Standard	Standard
Reverser	Standard	Standard	Standard	Standard	Standard
THRESHING/SEPARATING					
Separator Type	Rotary	Rotary	Rotary	Rotary	Multi Drum/Straw Walker
Rotor Length (mm/in.)	3124/123	3124/123	3124/123	3124/123	--
Rotor Diameter (mm/in.)	762/30	762/30	762/30	762/30	--
Rotor Speed Range (rpm)	210-1000	210-1000	210-1000	210-1000	220-990
Concave Area (m2/in.2)	1.1/1705	1.1/1705	1.1/1705	1.1/1705	1.35/2093
Separating Area (m2/in.2)	1.54/2390	1.54/2390	1.54/2390	1.54/2390	4.0/6200
Discharge Grate Area (m2/in.2)	0.36/555	0.36/555	0.45/698	0.45/698	n/a
CLEANING					
Front Chaffer (m2/in.2)	0.5/801	0.5/801	0.5/801	0.5/801	0.6/930
Front Chaffer Extension (m2/in.2)	N/A	N/A	0.8/1224	0.8/1224	--
Chaffer (m2/in.2)	2.5/3824	2.5/3824	2.5/3824	2.5/3824	3.06/9393
Sieve Area (m2/in.2)	2.1/3255	2.1/3255	2.1/3255	2.1/3255	2.64/4092
Total Cleaning Area (m2/in.2)	5.1/7905	5.1/7905	5.9/9145	5.9/9145	6.27/9719
Cleaning Fan Speed (rpm)	620-1350	620-1350	620-1350	620-1350	550-1350
GRAIN HANDLING					
Grain Tank Size (L/bu.)	10600/300	10600/300	14100/400	14100/400	11000/300
Unloading Auger Length (m/ft.)	6.9/22.5, 7.9/26, or 8.7/28.5	6.9/22.5, 7.9/26, or 8.7/28.5	6.9/22.5, 7.9/26, or 8.7/28.5	6.9/22.5, 7.9/26, or 8.7/28.5	7.05/23.5
Unloading Rate (L/sec. / bu/sec.)	116.3 / 3.3	116.3 / 3.3	135 / 3.8	135 / 3.8	115/3.3



Whether you need to curb compaction, reduce rutting, or simply want greater traction when tackling muddy fields, John Deere offers you multiple flotation choices. You're sure to find a flotation system that will fit your operation and your budget.

A 580/85R42 RIW dual tire option is available on a universal rim that can be dished in or out without axle spacers.

Low Sidewall (LSW) Drive-and-Steer Tires

You'll find some of the smoothest performance imaginable from our new LSW drive-and-steer tires. They offer a similar benefit solution as a track machine in a tire offering. That means you get superior traction and flotation when harvesting in soft, wet soil conditions. Also, they greatly reduce compaction and stubble damage to the tire. If that's not all, the LSW tires allow you to maintain transport speed without tire hop.

	S760	S770	S780	S790	T670
FRONT TIRES					
800/70R38 R1W (GY or FS)	X	X	X	X	
IF900/60R32 CFO R1 (FS)	X	X	X	X	
900/65R32 R2 (GY)	X	X	X	X	
IF1250/50R32 CFO R1W (FS)	X	X	X	X	
650/85R38 R1W Duals (GY, FS, or [Michelin] MI)	X	X	X	X	
580/85R42 R1W Duals (GY or FS)	X	X	X	X	
IF800/70R38 R1W CFO (GY, FS, or MI)		X	X	X	
520/85R42 R1 Duals (GY, FS)		X	X	X	
520/85R42 R1 Duals 157A8 (GY, FS)		X	X		
520/85R42 R2 Duals (GY, FS, or MI)	X	X	X	X	
520/85R42 R1 Duals (GY)					X
800/65R32 (MI or Mitas)					X
IF800/70R32 CFO (MI)					X
900/60R32 (Mitas SVT)					X
IF800/65R32 CFO (MI)					X
800/70R32 CHO (Mitas)					X
800/55R46 R1W (LSW)		X	X	X	
VF1250/35R46 CFO R2 (LSW)		X	X	X	
IF1100/45R46 CFO R1W (LSW)		X	X	X	
30 or 36" TRACKS					
ProDrive Transmission required		X	X	X	
REAR TIRES					
600/70R28 R1W (GY, FS)	X	X			
VF520/80R26 R1 (MI)	X	X			
23.1R26 R1 (FS)	X	X	X	X	
620/75R26 R1W (GY)	X	X	X	X	
VF620/70R26 R1 (MI)	X	X	X	X	
28LR26 R1W (GY)	X	X	X	X	
750/65R26 R1W (MI, FS, Mitas)	X	X	X	X	
710/65R26 R2 (GY)	X	X	X	X	
710/60R32 CFO 168 A8 R1W (LSW)		X	X	X	
VF750/65R26 R1W (FS)		X	X	X	
520/80R26 Cerebix (MI)					X
540/65R30 (Mitas)					X
600/65R28 (Mitas)					X

Put It On My Multi-Use Account...

For a flexible way to finance

SEED

with seasonal terms that allow
me to buy now and pay later[†]

With the purchasing power
to pay for essential

CROP PROTECTANTS

that safeguard my investment

And convenience that helps me get the

FERTILIZER

I need for a successful growing season



The **Multi-Use Account** from John Deere Financial is an essential financing solution that provides an additional source of capital, matches my cash flow and helps me get the important things I need to keep my business moving forward — all season long.

Learn more about the full potential of your account at MyMulti-UseAccount.com or MyMulti-UseAccount.ca

CROP INPUTS | FARM SUPPLIES | PARTS, SERVICE & ATTACHMENTS

Multi-Use Accounts are a service of John Deere Financial, f.s.b.
DSAA73568 Litho in U.S.A. (18-10)

[†]Activation/subscription required. Some additional accessories and/or components may be required. JDLink requires a cellular data connection to transfer information from machine to JDLink website. Consult your local John Deere Dealer for coverage availability.

 **JOHN DEERE
FINANCIAL**

Multi-Use Account

[†]Financing on approved John Deere Financial credit only.
See your Multi-Use Account merchant for complete details.